

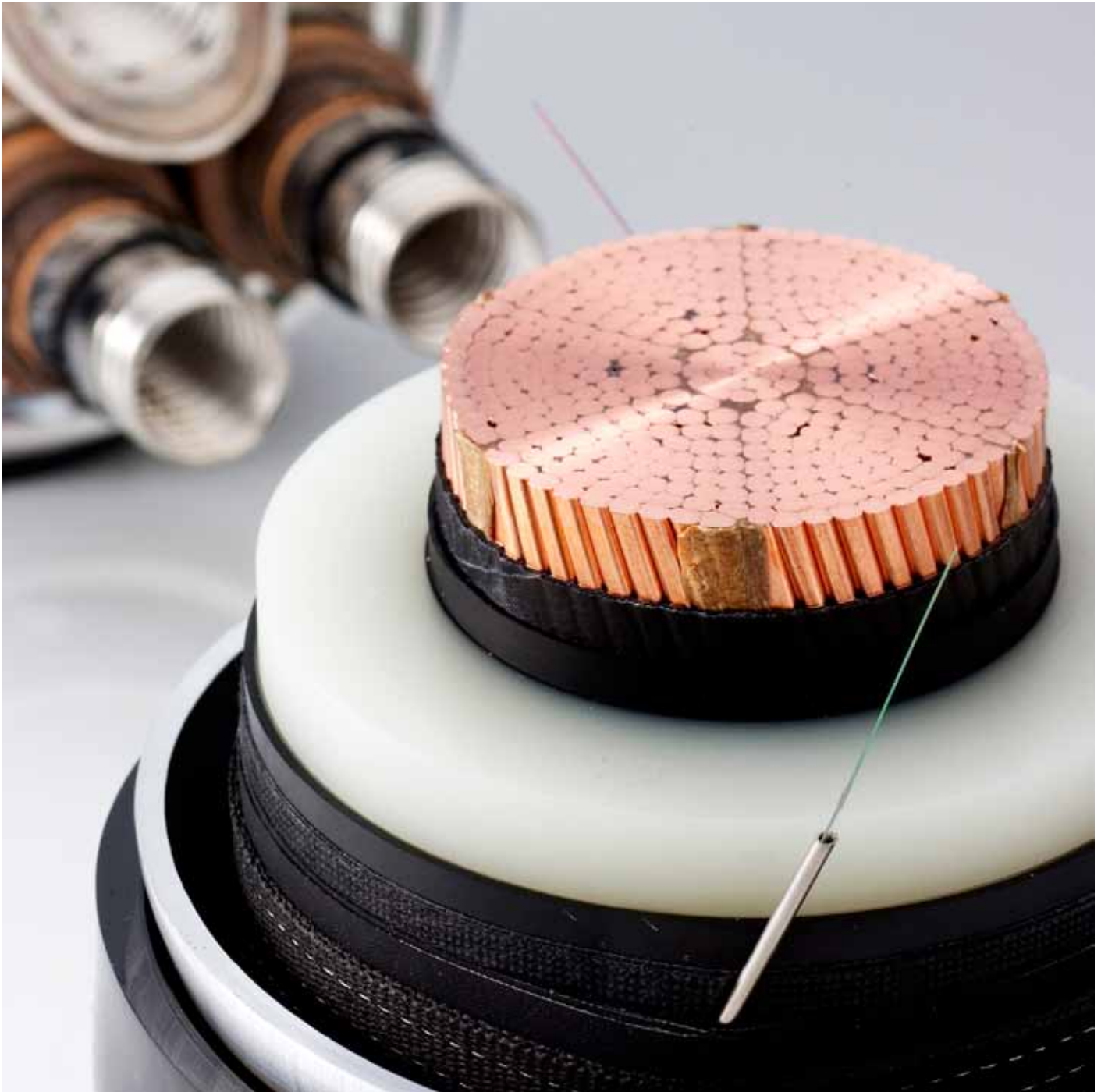

EHV CABLE SYSTEM

66~500kV XLPE Cable & Accessories



THE WORLD BEST CABLE SOLUTION LEADER

LS Cable & System supplies various cables and materials used for power grids and communication networks around the world across all industries providing its top class technology and excellent quality. The company has also developed state of the art products, such as superconductors, HVDC and submarine cables that will lead the future energy industry.

LS spun off from LG in 2003 as a group specializing in electronics, electrical systems, energy and materials.



LS Cable & System

Transmission Cable
Distribution Cable
Submarine Cable
Telecommunication Cable
Industrial Cable
Industrial Material

LSELECTRIC

Electric &
Automatic Equipments

LS-Nikko Copper

Copper Refinement

LS Mitron

Mechanical &
Electronic Parts

yesco
LNG

E1
LPG

GBON
Power &
Communication
Cables

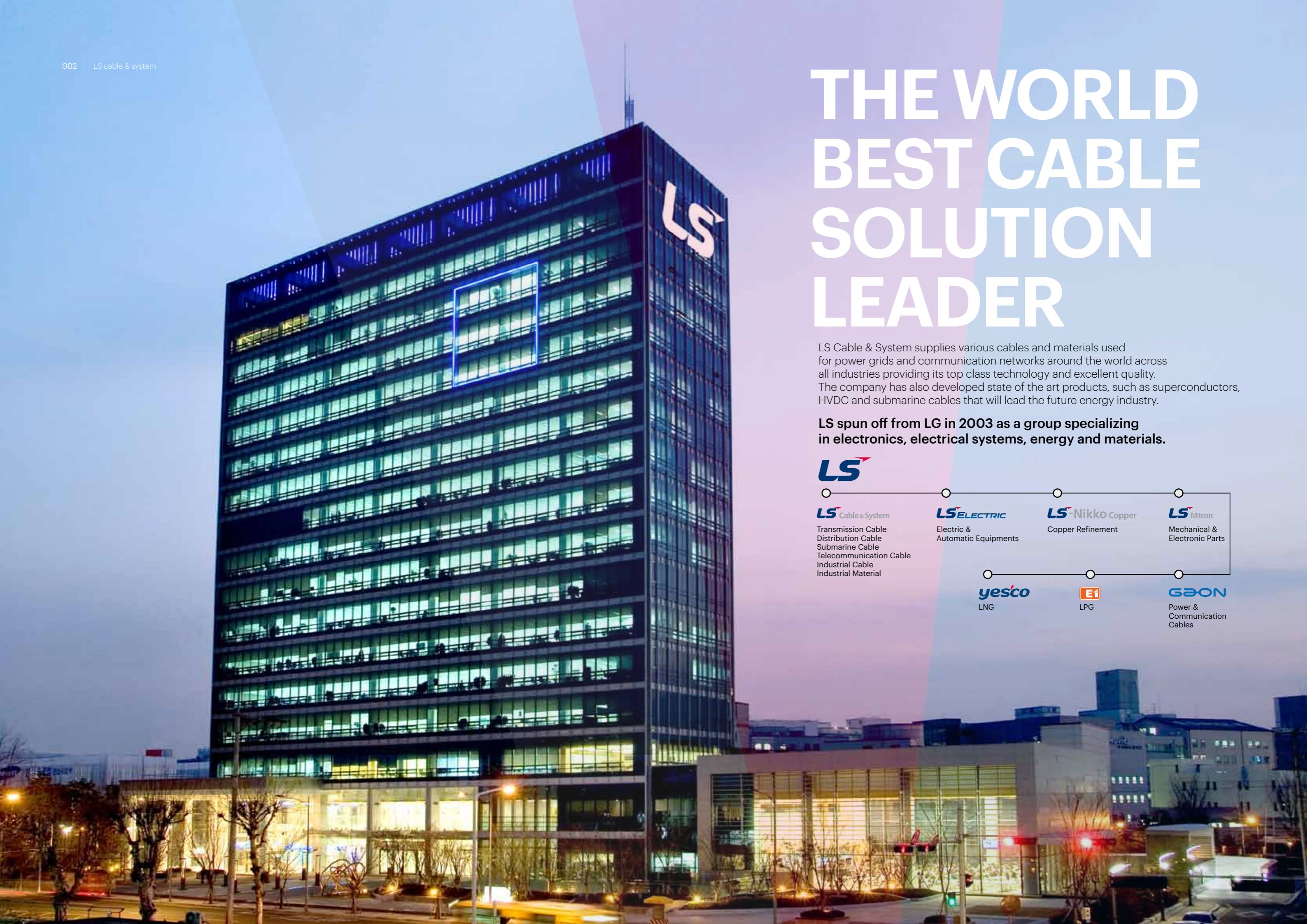

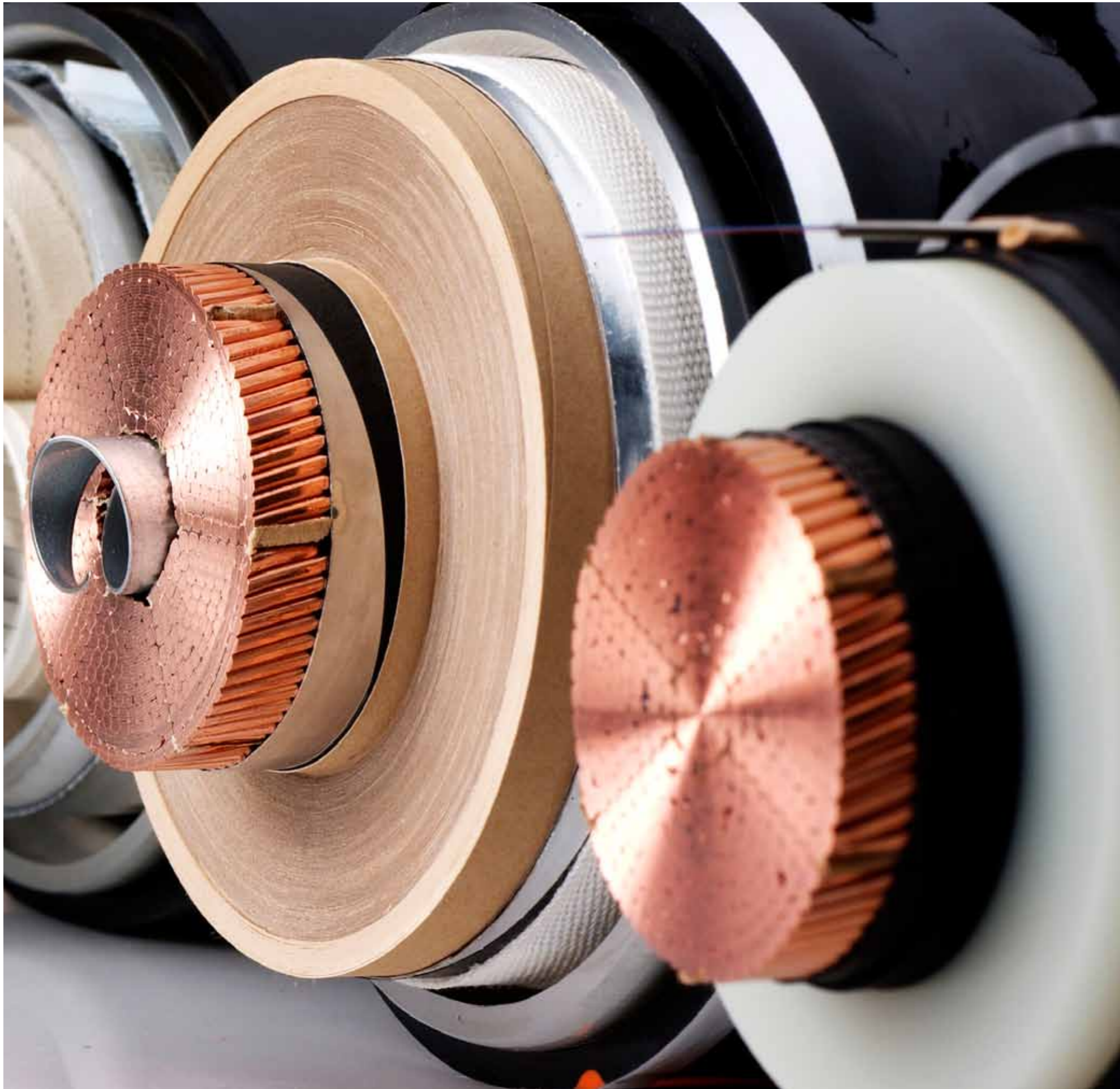

LS EHV Cable System

66~500kV XLPE Cable & Accessories

Our Philosophy

At LS Cable & System, we understand our responsibility and our potential in leading society to remarkable improvements in varied facets of human life and society. For the past many decades we successfully took the challenge of providing our clients with solutions and support systems to service their globe-spanning businesses. We recognize the significance of our contributing customer-oriented services for the betterment of the society and its operations. We believe that our responsibility should not end in mere execution of our customers' project, but should extend towards contributing our knowledge and expertise in returning value to their company and to the society within which they live. Our vision is to provide world class services and products to our clients with a sense of responsibility and accountability towards them, their employees and ultimately the society. We are determined to shoulder our responsibility of serving the society by protecting the environment. We bear the vision of alleviating the ill-effects on the ecosystem and human life using more advanced technology. We are persistently in the process of putting our philosophy in action.



Total Solution for Underground Transmission System

LS Cable & System is one of the world's leading manufacturers of extra high voltage cable and accessories and also one of a few total solution providers of underground transmission system. We are prominently capable and facilitated in researching, designing, developing, and manufacturing products and solutions with a heritage of decades as a cable manufacturer and ceaseless invest on quality control.

We provide power system from 66kV ~ 500kV such as XLPE cables, terminations, joints and other related products as some parts of our total solution maximizing the competitive advantage in 230kV and higher voltage system. Especially, the certificate for the satisfactory completion of Type Test and Pre-qualification Test by KEMA lasted for 365 days in 400kV XLPE cable and accessories and shows the quality of full range of our products and system.



Contents

Commitment to Our Customers

As an extra high voltage cable and accessories manufacturer and a division of LS Cable & System, we never stop researching, designing, developing, and manufacturing products with the higher level of quality to address the ever-changing demands in everyday life as well as in the industry. Our quality control meets the most delicate requirements of international standards and the high level of quality is recognized both by local and international clients. Our commitment to develop and deliver solutions to address our customers' needs and challenges keep our technology on the cutting edge and our know-how in the field more valuable, which our customers highly appreciate. We are looking forward to working with you.

1.00	Design & Construction of XLPE Cable	8
2.00	Manufacturing Process & VCV Line	10
3.00	Cable Construction & Continuous Current Ratings	12
4.00	XLPE Insulated Cables	13
5.00	Correction Factors for Various Laying Conditions	42
6.00	Permissible Short Circuit Currents	44
7.00	Accessories for EHV Cable Systems	61
8.00	Monitoring & Diagnosis System	64
9.00	Appendix	

1.00 Design & Construction of XLPE Cable

Structure of XLPE Cable

The XLPE Cable has the construction of a conductor (copper or aluminum) insulated with the cross-linked polyethylene and then shielded with metallic screen (corrugated and seamless aluminum or wire shield), to be covered by PVC or polyethylene for anti-corrosion.

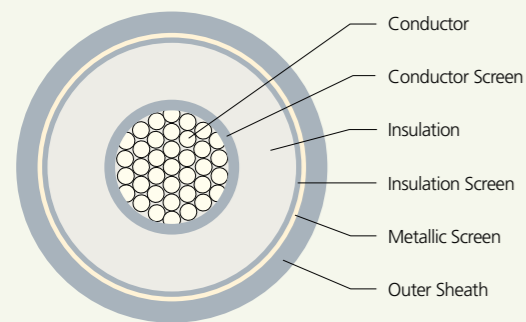

Insulation

The insulation material is extruded cross-linked polyethylene. The conductor screen, the insulation and the insulation screen mentioned to the following clause are extruded simultaneously in one process to ensure that the screen and insulation are intimately bonded together and free from all possibilities of voids between layers.

The extrusion process is carried out under strictly controlled atmospheric conditions.

The thickness of the insulation layer is the maximum value figured out from the design of the impulse voltage and A.C. voltage.

The conventional cross-linking process by saturated steam has frequently caused deterioration of the electrical characteristics of the insulation as treeing phenomena arose when put to use for long time. But the new process by N₂ gas has enabled to protect the electrical characteristics from being deteriorated and to lessen the thickness of the insulation and accordingly the cable's outer diameter itself.

Insulation Screen

The insulation screen is provided over the insulation by extruding the semi-conducting compound concentrically and circularly to minimize the possibility of ionization on the outer surface of the dielectric.

Metallic Screen

The metallic screen consists of the wire shield, the corrugated aluminum sheath or the lead sheath. The corrugated aluminum sheath and the lead sheath is also adopted where the surface of duct is poor and where moisture is high.

Outer Sheath

To protect the metallic sheath from electrical or chemical corrosion, it is covered by PE or PVC.

Conductor

The conductor consists of annealed copper or hard aluminum stranded wires and classified into three (3) major types of concentric, compacted circular and segmental compacted circular.

The concentric is the wires wound up concentrically, the compacted circular conductor consists of segments wound up and then compacted. Normally the segmental compacted circular conductor has four (4) segments and is applied for the cross-section over than 800mm², to prevent the increase of A.C. resistance caused by skin effect. When the conductor's cross-section is less than 630mm², the compacted circular is applied generally.

Conductor Screen

The conductor screen consists of an extruded semi-conducting polyethylene to minimize electrical stresses due to the stranded configuration of the conductor. The semi-conducting material used for conductor screen has no deleterious effect on the conductor. Semi-conducting tape is sometimes applied as a separator.

Corrugated Aluminum Sheath Cable



Smooth Welded Aluminum Sheath Cable

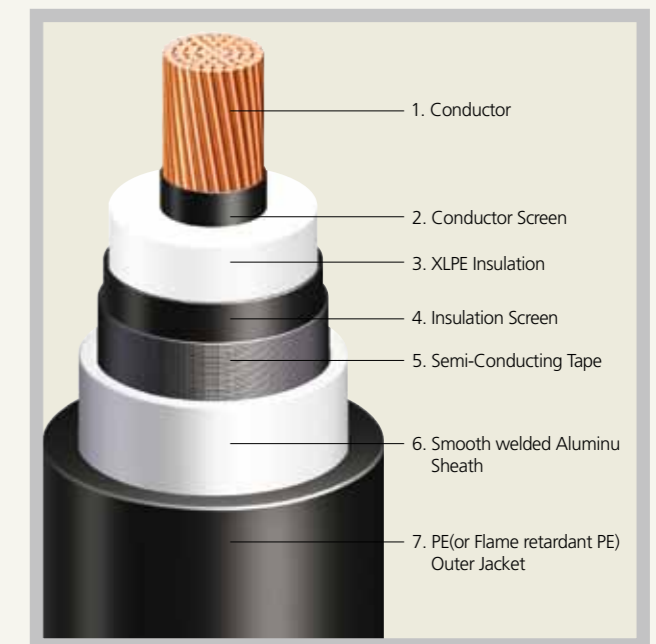

Lead Sheath Cable

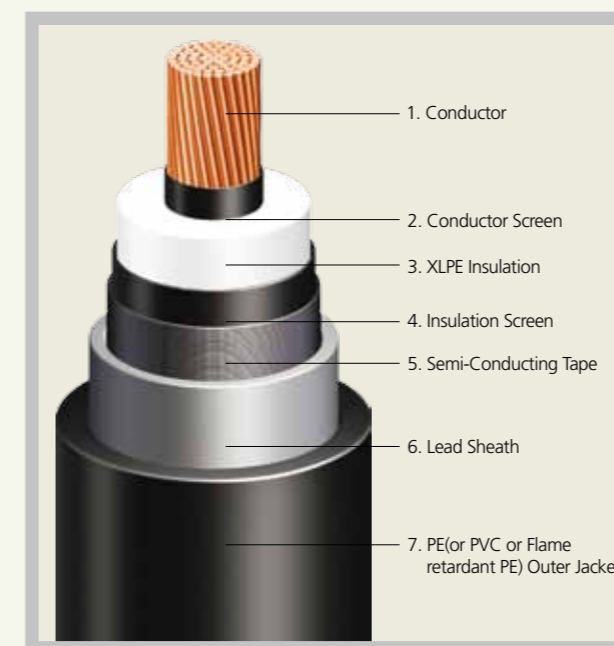

Copper Wire Shield Cable

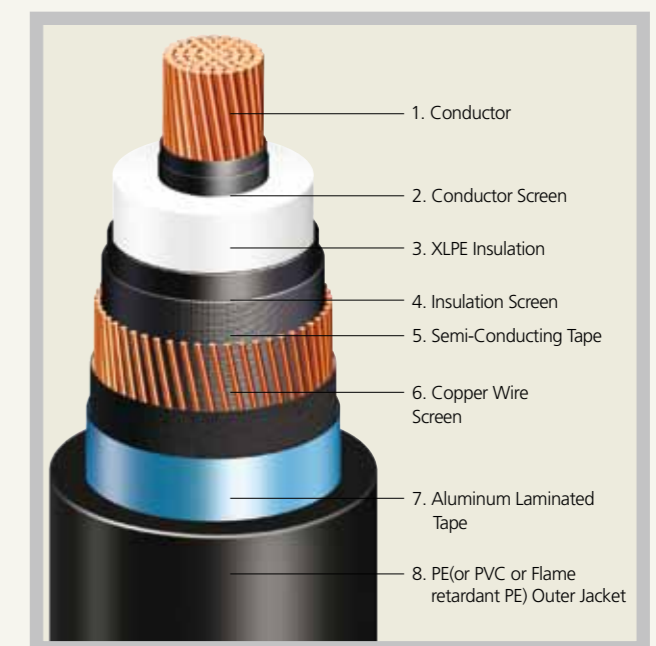

2.00 Manufacturing Process & VCV Line

The system adopted for insulation of the XLPE Cable is VCV and N₂ gas is used for cross linking, and the line is extruded in a vertical type. The outstanding characteristics of the XLPE Cable manufactured in application of this system are :

1. The insulation has no eccentricity.
2. The cross-linking by use of N₂ gas guarantees excellent electrical characteristics of the insulation.
3. The simultaneous extrusion of the inner and outer semi-conducting layers and the insulation prevents treeing and other irregularities.
4. Uniformity of quality is maintained of all products as the manufacturing processes are controlled by computer.

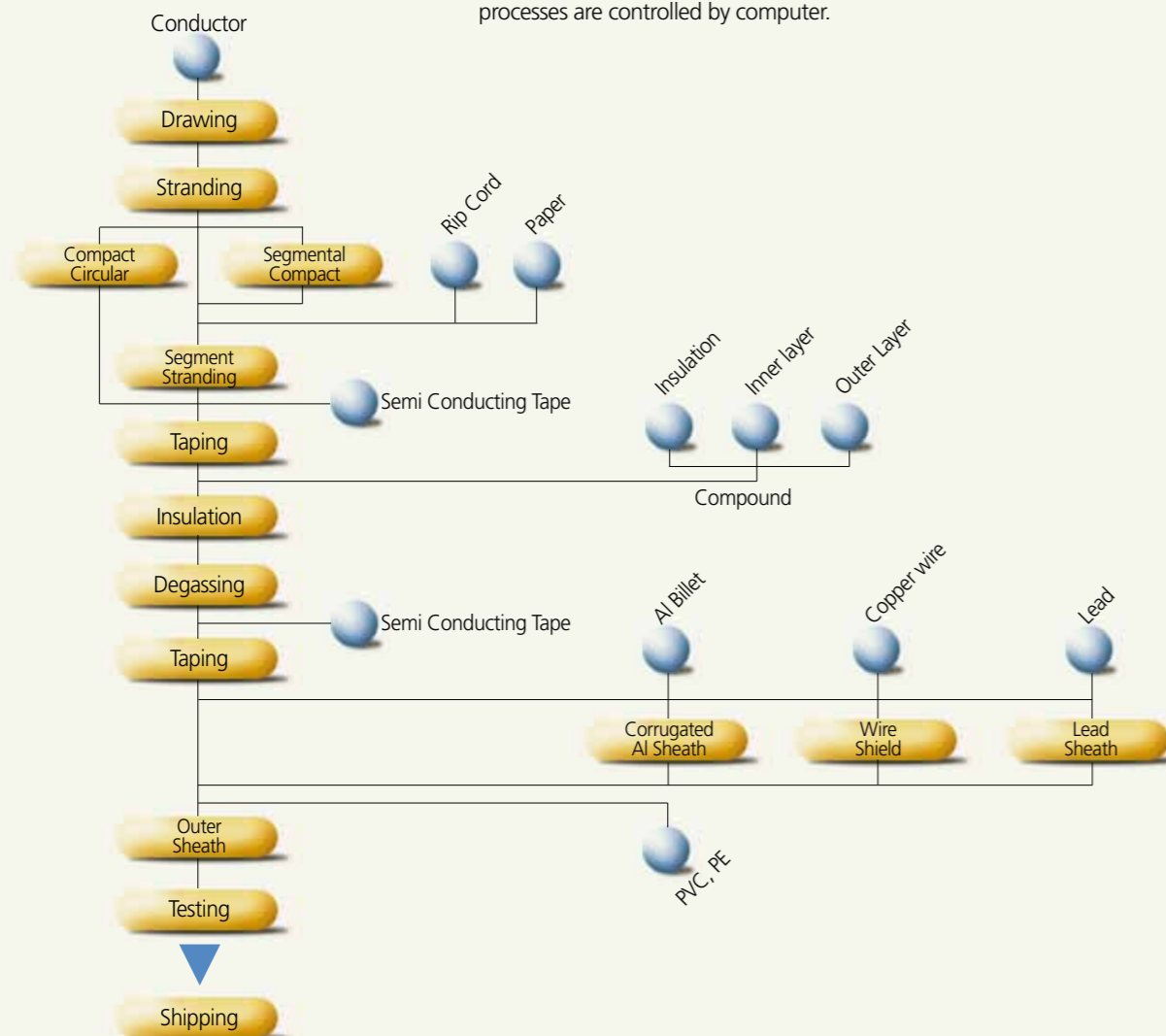

Extrusion

The conductor screen, the insulation and the insulation screen are simultaneously extruded with the compounds supplied from the clean room.

Cross-Linking and Cooling

The cross-linking takes place in curing zone of A by circulating N₂ gas and the insulation is formed into core through precooling zone of B and cooling zone of C.

Pay Off

The conductor wound up around the drum is set at pay off to run to metering capstan.

Take Up

The cable comes to be wound up again around the drum to go into the next process.

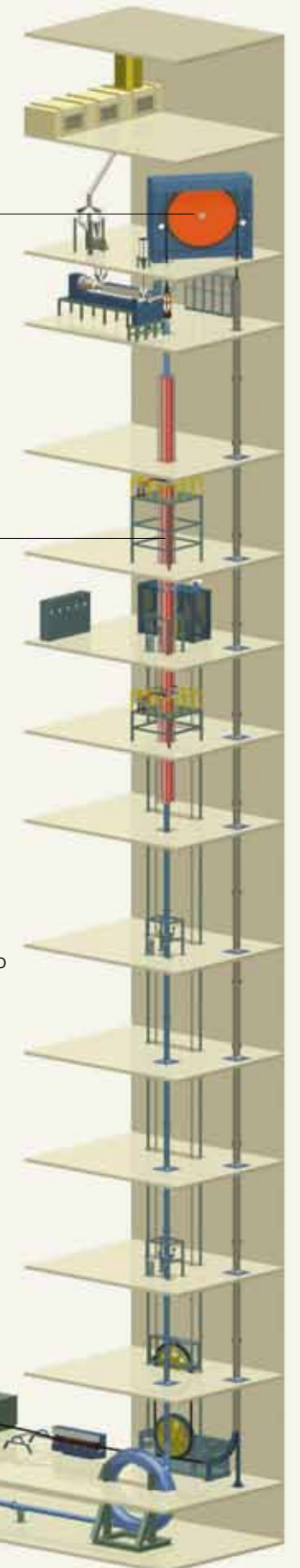

3.00 Cable Construction & Continuous Current Ratings

The continuous current capacity is calculated in accordance with IEC 60287.

Laying Conditions

- 1) Ground Temperature : 25°C
- 2) Depth of Laying : 1.5m
- 3) Soil Thermal Resistivity : 1.0°Cm/W
- 4) Ambient Temperature : 40°C
- 5) Max. Conductor Temperature : 90°C
- 6) Cable Formation : Flat (S=2D)
S : Distance between cables / D : Cable diameter
- 7) Frequency : 50Hz
- 8) Load factor : 100%

Maximum Permissible Conductor Temperature

Normal Operation	Emergency Operation	Short Circuit
90°C	105°C	250°C

- 1) Normal Operation
Normal operation is meant to be maintained through out a given period of time everyday or continuously, without affecting the operation.
- 2) Emergency Load
Emergency load is meant to be maintained for a short time under the condition of system breakdown or under the state of excessively loaded operation, without causing a defect.
- 3) Short Circuit
Short circuit is meant to cause no defect of the cable when an irregular current, flows for short time due to shorting or earthing.



4.00 XLPE Insulated Cables

- 4.01 36/66 (72.5)kV with Corrugated Aluminum Sheath
- 4.02 36/66 (72.5)kV with Smooth Welded Aluminum Sheath
- 4.03 36/66 (72.5)kV with Lead Sheath
- 4.04 36/66 (72.5)kV with Copper Wire Shield

- 4.05 64/110 (123)kV with Corrugated Aluminum Sheath
- 4.06 64/110 (123)kV with Smooth Welded Aluminum Sheath
- 4.07 64/110 (123)kV with Lead Sheath
- 4.08 64/110 (123)kV with Copper Wire Shield

- 4.09 76/132 (145)kV with Corrugated Aluminum Sheath
- 4.10 76/132 (145)kV with Smooth Welded Aluminum Sheath
- 4.11 76/132 (145)kV with Lead Sheath
- 4.12 76/132 (145)kV with Copper Wire Shield

- 4.13 87/161 (170)kV with Corrugated Aluminum Sheath
- 4.14 87/161 (170)kV with Smooth Welded Aluminum Sheath
- 4.15 87/161 (170)kV with Lead Sheath
- 4.16 87/161 (170)kV with Copper Wire Shield

- 4.17 127/230 (245)kV with Corrugated Aluminum Sheath
- 4.18 127/230 (245)kV with Smooth Welded Aluminum Sheath
- 4.19 127/230 (245)kV with Lead Sheath
- 4.20 127/230 (245)kV with Copper Wire Shield

- 4.21 220/400 (420)kV with Corrugated Aluminum Sheath
- 4.22 220/400 (420)kV with Smooth Welded Aluminum Sheath
- 4.23 220/400 (420)kV with Lead Sheath
- 4.24 220/400 (420)kV with Copper Wire Shield

- 4.25 290/500 (550)kV with Corrugated Aluminum Sheath
- 4.26 290/500 (550)kV with Smooth Welded Aluminum Sheath
- 4.27 290/500 (550)kV with Lead Sheath
- 4.28 290/500 (550)kV with Copper Wire Shield

4.01 36/66(72.5)kV with Corrugated Aluminum Sheath

Corrugated Aluminum Sheath



Construction

- Copper Conductor
- XLPE Insulation
- Al sheath
- PE(or PVC or Flame retardant PE) Outer Jacket

Continuous current ratings (load factor=100%) for one circuit in operation (Ampere)

Cross-Sectional Area (mm ²)	Direct Buried	Pipe Duct	In Air	
			Trefoil	Flat (S=2D)
240	524	491	598	671
300	592	556	682	770
400	671	631	781	888
500	762	714	894	1025
630	878	808	1023	1187
800	965	928	1150	1355
1000	1119	1075	1361	1615
1200	1198	1146	1460	1745
1600	1352	1357	1654	2030
2000	1468	1475	1800	2273

Constructional Data (Nominal)

Cross-Sectional Area	Conductor		Thickness of Conductor Screen Approx.	Thickness of Insulation	Thickness of Insulation Screen Approx.	Thickness of Aluminum Sheath	Thickness of Outer Sheath	Outer Diameter of Cable	Weight of Cable	Max. DC Conductor Resistance at 20°C	Capacitance
	Shape	Diameter									
240	Compact Round Stranded	18.1	1.0	11.0	1.0	1.6	3.5	69	5.5	0.0754	0.20
300		20.4	1.0	11.0	1.0	1.6	3.5	72	6.3	0.0601	0.22
400		23.2	1.0	11.0	1.0	1.7	3.5	75	7.2	0.0470	0.23
500		26.3	1.0	11.0	1.0	1.8	4.0	79	8.6	0.0366	0.25
630		30.2	1.0	11.0	1.0	1.8	4.0	83	10.1	0.0283	0.28
800	34.0	1.0	11.0	1.0	1.9	4.0	87	12.0	0.0221	0.30	
1000	38.7	1.0	11.0	1.0	2.0	4.0	92	14.4	0.0176	0.33	
1200	Segment Stranded (Miliken)	41.8	1.0	11.0	1.0	2.1	4.5	98	16.7	0.0151	0.35
1600		48.1	1.0	11.0	1.0	2.2	4.5	105	20.9	0.0113	0.49
2000		54.3	1.0	11.0	1.0	2.4	4.5	112	25.4	0.0090	0.43

4.02 36/66(72.5)kV with Smooth Welded Aluminum Sheath

Smooth Welded Aluminum Sheath



Construction

- Copper Conductor
- XLPE Insulation
- Smooth welded Al Sheath
- PE(or Flame retardant PE) Outer Jacket

Continuous current ratings (load factor=100%) for one circuit in operation (Ampere)

Cross-Sectional Area (mm ²)	Direct Buried	Pipe Duct	In Air	
			Trefoil	Flat (S=2D)
240	535	477	588	667
300	590	541	669	766
400	672	615	767	887
500	763	702	877	1025
630	866	796	999	1189
800	969	894	117	1358
1000	1113	1026	1299	1601
1200	1193	1104	1391	1738
1600	1343	1247	1557	2017
2000	1458	1358	1679	2249

Constructional Data (Nominal)

Cross-Sectional Area	Conductor		Thickness of Conductor Screen Approx.	Thickness of Insulation	Thickness of Insulation Screen Approx.	Thickness of Lead Sheath	Thickness of Outer Sheath	Outer Diameter of Cable	Weight of Cable	Max. DC Conductor Resistance at 20°C	Capacitance
	Shape	Diameter									
240	Compact Round Stranded	18.1	1.0	11.0	1.0	0.8	3.5	65	5.2	0.0754	0.20
300		20.4	1.0	11.0	1.0	0.8	3.5	67	5.9	0.0601	0.22
400		23.2	1.0	11.0	1.0	0.8	3.5	70	6.8	0.0470	0.23
500		26.3	1.0	11.0	1.0	0.8	4.0	74	8.1	0.0366	0.25
630		30.2	1.0	11.0	1.0	0.8	4.0	78	9.5	0.0283	0.28
800	34.0	1.0	11.0	1.0	0.8	4.0	82	11.4	0.0221	0.30	
1000	38.7	1.0	11.0	1.0	0.8	4.0	86	13.9	0.0176	0.33	
1200	Segment Stranded (Miliken)	41.8	1.0	11.0	1.0	0.8	4.5	90	15.6	0.0151	0.35
1600		48.1	1.0	11.0	1.0	0.8	4.5	97	19.7	0.0113	0.49
2000		54.3	1.0	11.0	1.0	0.8	4.5	102	23.8	0.0090	0.43

36/66 (72.5) kV
64/110 (123) kV
76/132 (145) kV
87/161 (170) kV
127/230 (245) kV
220/400 (420) kV
290/500 (550) kV

4.03 36/66(72.5)kV with Lead Sheath

Lead Sheath



Construction

- Copper Conductor
- XLPE Insulation
- Lead sheath
- PE(or PVC or Flame retardant PE) Outer Jacket

Continuous current ratings (load factor=100%) for one circuit in operation (Ampere)

Cross-Sectional Area (mm ²)	Direct Buried	Pipe Duct	In Air	
			Trefoil	Flat (S=2D)
240	527	480	599	677
300	597	543	685	778
400	681	619	792	903
500	776	709	912	1046
630	884	812	1051	1218
800	994	913	1191	1396
1000	1153	1063	1420	1658
1200	1242	1144	1538	1806
1600	1417	1310	1771	2116
2000	1556	1443	1953	2379

Constructional Data (Nominal)

Cross-Sectional Area	Conductor			Thickness of Conductor Screen Approx.	Thickness of Insulation	Thickness of Insulation Screen Approx.	Thickness of Aluminum Sheath	Thickness of Outer Sheath	Outer Diameter of Cable	Weight of Cable	Max. DC Conductor Resistance at 20°C	Capacitance
	Shape	Diameter	mm									
240	Compact Round Stranded	18.1	1.0	11.0	1.0	1.6	3.5	61	7.3	0.0754	0.20	
300		20.4	1.0	11.0	1.0	1.6	3.5	64	8.1	0.0601	0.22	
400		23.2	1.0	11.0	1.0	1.6	3.5	66	9.1	0.0470	0.23	
500		26.3	1.0	11.0	1.0	1.6	4.0	71	10.6	0.0366	0.25	
630		30.2	1.0	11.0	1.0	1.6	4.0	74	12.3	0.0283	0.28	
800	34.0	1.0	11.0	1.0	1.7	4.0	78	14.6	0.0221	0.30		
1000	38.7	1.0	11.0	1.0	1.7	4.0	83	17.2	0.0176	0.33		
1200	Segment Stranded (Miliken)	41.8	1.0	11.0	1.0	1.8	4.5	87	19.4	0.0151	0.35	
1600		48.1	1.0	11.0	1.0	1.8	4.5	94	23.8	0.0113	0.39	
2000		54.3	1.0	11.0	1.0	1.9	4.5	100	28.5	0.0090	0.43	

4.04 36/66(72.5)kV with Copper Wire Shield

Copper Wire Shield



Construction

- Copper Conductor
- XLPE Insulation
- Copper wire shield
- PE(or PVC or Flame retardant PE) Outer Jacket

Continuous current ratings (load factor=100%) for one circuit in operation (Ampere)

Cross-Sectional Area (mm ²)	Direct Buried	Pipe Duct	In Air	
			Trefoil	Flat (S=2D)
240	530	483	606	692
300	599	544	693	795
400	683	616	802	925
500	780	729	929	1075
630	886	828	1066	1247
800	997	929	1210	1432
1000	1173	1087	1473	1728
1200	1270	1173	1611	1894
1600	1465	1375	1883	2245
2000	1627	1530	2111	2556

Constructional Data (Nominal)

Cross-Sectional Area	Conductor			Thickness of Conductor Screen Approx.	Thickness of Insulation	Thickness of Insulation Screen Approx.	Diameter & Number of Copper Wires	Thickness of Outer Sheath	Outer Diameter of Cable	Weight of Cable	Max. DC Conductor Resistance at 20°C	Capacitance
	Shape	Diameter	mm									
240	Compact Round Stranded	18.1	1.0	11.0	1.0	1.2 x 40	3.5	58	4.4	0.0754	0.20	
300		20.4	1.0	11.0	1.0	1.2 x 40	3.5	60	5.1	0.0601	0.22	
400		23.2	1.0	11.0	1.0	1.2 x 40	3.5	63	5.9	0.0470	0.23	
500		26.3	1.0	11.0	1.0	1.2 x 40	4.0	66	7.2	0.0366	0.25	
630		30.2	1.0	11.0	1.0	1.2 x 40	4.0	71	8.6	0.0283	0.28	
800	34.0	1.0	11.0	1.0	1.2 x 40	4.0	75	10.4	0.0221	0.30		
1000	38.7	1.0	11.0	1.0	1.2 x 40	4.0	80	12.7	0.0176	0.33		
1200	Segment Stranded (Miliken)	41.8	1.0	11.0	1.0	1.2 x 40	4.5	85	14.7	0.0151	0.35	
1600		48.1	1.0	11.0	1.0	1.2 x 40	4.5	91	18.7	0.0113	0.39	
2000		54.3	1.0	11.0	1.0	1.2 x 40	4.5	97	22.7	0.0090	0.43	

36/66 (72.5) kV
64/110 (123) kV
76/132 (145) kV
87/161 (170) kV
127/230 (245) kV
220/400 (420) kV
290/500 (550) kV

4.05 64/110(123)kV with Corrugated Aluminum Sheath

Corrugated Aluminum Sheath



Construction

- Copper Conductor
- XLPE Insulation
- Al sheath
- PE(or PVC or Flame retardant PE) Outer Jacket

Continuous current ratings (load factor=100%) for one circuit in operation (Ampere)

Cross-Sectional Area (mm ²)	Direct Buried	Pipe Duct	In Air	
			Trefoil	Flat (S=2D)
240	520	491	592	657
300	587	550	677	755
400	667	639	775	873
500	758	725	889	1006
630	860	821	1020	1169
800	961	915	1147	1333
1000	1109	1057	1346	1581
1200	1187	1180	1451	1717
1600	1338	1332	1635	1995
2000	1458	1447	1787	2236
2500	1538	1526	1885	2358

Constructional Data (Nominal)

Cross-Sectional Area	Conductor		Thickness of Conductor Screen Approx.	Thickness of Insulation	Thickness of Insulation Screen Approx.	Thickness of Lead Sheath	Thickness of Outer Sheath	Outer Diameter of Cable	Weight of Cable	Max. DC Conductor Resistance at 20°C	Capacitance
	Shape	Diameter									
240	Compact Round Stranded	18.1	1.2	14.0	1.0	1.7	3.5	76	6.3	0.0754	0.17
300		20.4	1.2	14.0	1.0	1.8	3.5	78	7.0	0.0601	0.18
400		23.2	1.2	14.0	1.0	1.8	3.5	81	8.0	0.0470	0.20
500		26.3	1.2	14.0	1.0	1.9	4.0	86	9.3	0.0366	0.21
630		30.2	1.2	14.0	1.0	2.0	4.0	90	11.0	0.0283	0.23
800		34.0	1.2	14.0	1.0	2.0	4.0	94	12.9	0.0221	0.25
1000	Segment Stranded (Miliken)	38.7	1.2	14.0	1.0	2.1	4.0	99	15.4	0.0176	0.28
1200		41.8	1.2	14.0	1.0	2.2	4.5	104	17.7	0.0151	0.30
1600		48.1	1.2	14.0	1.0	2.4	4.5	111	22.1	0.0113	0.33
2000		54.3	1.2	14.0	1.0	2.5	4.5	118	26.5	0.0090	0.36
2500		63.0	1.2	14.0	1.0	2.6	4.5	128	33.0	0.0072	0.40

4.06 64/110(123)kV with Smooth Welded Aluminum Sheath

Smooth Welded Aluminum Sheath



Construction

- Copper Conductor
- XLPE Insulation
- Smooth welded Al Sheath
- PE(or Flame retardant PE) Outer Jacket

Continuous current ratings (load factor=100%) for one circuit in operation (Ampere)

Cross-Sectional Area (mm ²)	Direct Buried	Pipe Duct	In Air	
			Trefoil	Flat (S=2D)
240	520	479	585	659
300	587	540	665	755
400	668	616	763	874
500	759	700	871	1010
630	861	796	992	1170
800	963	894	1109	1336
1000	1106	1025	1287	1573
1200	1185	1102	1337	1707
1600	1333	1243	1541	1981
2000	1447	1353	1663	2208
2500	1556	1458	1781	2456

Constructional Data (Nominal)

Cross-Sectional Area	Conductor		Thickness of Conductor Screen Approx.	Thickness of Insulation	Thickness of Insulation Screen Approx.	Thickness of Lead Sheath	Thickness of Outer Sheath	Outer Diameter of Cable	Weight of Cable	Max. DC Conductor Resistance at 20°C	Capacitance
	Shape	Diameter									
240	Compact Round Stranded	18.1	1.2	14.0	1.0	0.9	3.5	71	5.8	0.0754	0.17
300		20.4	1.2	14.0	1.0	0.9	3.5	73	6.5	0.0601	0.18
400		23.2	1.2	14.0	1.0	0.9	3.5	76	7.4	0.0470	0.20
500		26.3	1.2	14.0	1.0	0.9	4.0	80	8.8	0.0366	0.21
630		30.2	1.2	14.0	1.0	0.9	4.0	84	10.4	0.0283	0.23
800		34.0	1.2	14.0	1.0	0.9	4.0	88	12.3	0.0221	0.25
1000	Segment Stranded (Miliken)	38.7	1.2	14.0	1.0	0.9	4.0	92	14.7	0.0176	0.28
1200		41.8	1.2	14.0	1.0	0.9	4.5	96	16.5	0.0151	0.30
1600		48.1	1.2	14.0	1.0	0.9	4.5	103	20.6	0.0113	0.33
2000		54.3	1.2	14.0	1.0	0.9	4.5	109	24.8	0.0090	0.36
2500		63.0	1.2	14.0	1.0	0.9	4.5	118	30.4	0.0072	0.40

4.07 64/110(123)kV with Lead Sheath

Lead Sheath



Construction

- Copper Conductor
- XLPE Insulation
- Lead Sheath
- PE(or PVC or Flame retardant PE) Outer Jacket

Continuous current ratings (load factor=100%) for one circuit in operation (Ampere)

Cross-Sectional Area (mm ²)	Direct Buried	Pipe Duct	In Air	
			Trefoil	Flat (S=2D)
240	525	482	597	668
300	594	545	682	766
400	678	621	788	889
500	772	711	907	1029
630	880	813	1045	1198
800	990	914	1184	1373
1000	1147	1063	1407	1627
1200	1236	1145	1524	1771
1600	1408	1309	1752	2074
2000	1546	1441	1931	2330
2500	1682	1577	2112	2614

Constructional Data (Nominal)

Cross-Sectional Area	Conductor		Thickness of Conductor Screen Approx.	Thickness of Insulation	Thickness of Insulation Screen Approx.	Thickness of Aluminum Sheath	Thickness of Outer Sheath	Outer Diameter of Cable	Weight of Cable	Max. DC Conductor Resistance at 20°C	Capacitance
	Shape	Diameter									
240	Compact Round Stranded	18.1	1.2	14.0	1.0	1.6	3.5	68	8.2	0.0754	0.17
300		20.4	1.2	14.0	1.0	1.6	3.5	70	9.0	0.0601	0.18
400		23.2	1.2	14.0	1.0	1.6	3.5	73	10.1	0.0470	0.20
500		26.3	1.2	14.0	1.0	1.6	4.0	77	11.6	0.0366	0.21
630		30.2	1.2	14.0	1.0	1.7	4.0	81	13.6	0.0283	0.23
800	34.0	1.2	14.0	1.0	1.8	4.0	85	15.9	0.0221	0.25	
1000	38.7	1.2	14.0	1.0	1.8	4.0	89	18.6	0.0176	0.28	
1200	Segment Stranded (Miliken)	41.8	1.2	14.0	1.0	1.8	4.5	93	20.6	0.0151	0.30
1600		48.1	1.2	14.0	1.0	1.9	4.5	100	25.4	0.0113	0.33
2000		54.3	1.2	14.0	1.0	2.0	4.5	106	30.2	0.0090	0.36
2500		63.0	1.2	14.0	1.0	2.2	4.5	115	37.1	0.0072	0.40

4.08 64/110(123)kV with Copper Wire Shield

Copper Wire Shield



Construction

- Copper Conductor
- XLPE Insulation
- Copper wire shield
- PE(or PVC or Flame retardant PE) Outer Jacket

Continuous current ratings (load factor=100%) for one circuit in operation (Ampere)

Cross-Sectional Area (mm ²)	Direct Buried	Pipe Duct	In Air	
			Trefoil	Flat (S=2D)
240	528	495	605	682
300	597	559	692	783
400	681	650	800	909
500	775	739	922	1053
630	884	841	1065	1226
800	994	945	1208	1406
1000	1169	1106	1465	1695
1200	1264	1231	1595	1849
1600	1456	1415	1860	2185
2000	1618	1570	2089	2487
2500	1706	1656	2203	2623

Constructional Data (Nominal)

Cross-Sectional Area	Conductor		Thickness of Conductor Screen Approx.	Thickness of Insulation	Thickness of Insulation Screen Approx.	Diameter & Number of Copper Wires	Thickness of Outer Sheath	Outer Diameter of Cable	Weight of Cable	Max. DC Conductor Resistance at 20°C	Capacitance
	Shape	Diameter									
240	Compact Round Stranded	18.1	1.2	14.0	1.0	1.2 x 40	3.5	64	5.0	0.0754	0.17
300		20.4	1.2	14.0	1.0	1.2 x 40	3.5	66	5.7	0.0601	0.18
400		23.2	1.2	14.0	1.0	1.2 x 40	3.5	69	6.6	0.0470	0.20
500		26.3	1.2	14.0	1.0	1.2 x 40	4.0	73	7.9	0.0366	0.21
630		30.2	1.2	14.0	1.0	1.2 x 40	4.0	77	9.4	0.0283	0.23
800	34.0	1.2	14.0	1.0	1.2 x 40	4.0	81	11.2	0.0221	0.25	
1000	38.7	1.2	14.0	1.0	1.2 x 40	4.0	86	13.6	0.0176	0.28	
1200	Segment Stranded (Miliken)	41.8	1.2	14.0	1.0	1.2 x 40	4.5	91	15.6	0.0151	0.30
1600		48.1	1.2	14.0	1.0	1.2 x 40	4.5	97	19.6	0.0113	0.33
2000		54.3	1.2	14.0	1.0	1.2 x 40	4.5	103	23.7	0.0090	0.36
2500		63.0	1.2	14.0	1.0	1.2 x 40	4.5	111	29.0	0.0072	0.40

36/66 (72.5) kV
64/110 (123) kV
76/132 (145) kV
87/161 (170) kV
127/230 (245) kV
220/400 (420) kV
290/500 (550) kV

4.09 76/132(145)kV with Corrugated Aluminum Sheath

Corrugated Aluminum Sheath



Construction

- Copper Conductor
- XLPE Insulation
- Al sheath
- PE(or PVC or Flame retardant PE) Outer Jacket

Continuous current ratings (load factor=100%) for one circuit in operation (Ampere)

Cross-Sectional Area (mm ²)	Direct Buried	Pipe Duct	In Air	
			Trefoil	Flat (S=2D)
240	519	486	589	649
300	585	547	671	742
400	665	635	770	858
500	755	716	883	992
630	856	814	1011	1151
800	956	942	1137	1313
1000	1103	1093	1333	1555
1200	1185	1170	1439	1695
1600	1333	1324	1627	1972
2000	1452	1435	1777	2211
2500	1530	1512	1872	2330

Constructional Data (Nominal)

Cross-Sectional Area	Conductor			Thickness of Conductor Screen Approx.	Thickness of Insulation	Thickness of Insulation Screen Approx.	Thickness of Lead Sheath	Thickness of Outer Sheath	Outer Diameter of Cable	Weight of Cable	Max. DC Conductor Resistance at 20°C	Capacitance
	Shape	Diameter	mm									
240	Compact Round Stranded	18.1	1.5	16.0	1.3	1.8	4.5	83	7.1	0.0754	0.16	
300		20.4	1.5	16.0	1.3	1.8	4.5	86	7.9	0.0601	0.17	
400		23.2	1.5	16.0	1.3	1.9	4.5	89	8.9	0.0470	0.18	
500		26.3	1.5	16.0	1.3	2.0	4.5	92	10.2	0.0366	0.20	
630		30.2	1.5	16.0	1.3	2.1	4.5	97	11.9	0.0283	0.21	
800	34.0	1.5	16.0	1.3	2.2	4.5	101	14.0	0.0221	0.23		
1000	38.7	1.5	16.0	1.3	2.2	4.5	106	16.6	0.0176	0.25		
1200	Segment Stranded (Miliken)	41.8	1.5	16.0	1.3	2.3	4.5	110	18.6	0.0151	0.27	
1600		48.1	1.5	16.0	1.3	2.4	4.5	116	22.9	0.0113	0.30	
2000		54.3	1.5	16.0	1.3	2.6	4.5	124	27.4	0.0090	0.32	
2500		63.0	1.5	16.0	1.3	2.8	4.5	131	34.3	0.0072	0.36	

4.10 76/132(145)kV with Smooth Welded Aluminum Sheath

Smooth Welded Aluminum Sheath



Construction

- Copper Conductor
- XLPE Insulation
- Smooth welded Al Sheath
- PE(or Flame retardant PE) Outer Jacket

Continuous current ratings (load factor=100%) for one circuit in operation (Ampere)

Cross-Sectional Area (mm ²)	Direct Buried	Pipe Duct	In Air	
			Trefoil	Flat (S=2D)
240	519	480	583	651
300	586	542	663	746
400	666	618	760	863
500	757	702	867	998
630	859	798	988	1156
800	960	892	1105	1319
1000	1102	1026	1279	1552
1200	1180	1102	1368	1687
1600	1327	1243	1531	1958
2000	1441	1347	1653	2181
2500	1549	1456	1771	2426

Constructional Data (Nominal)

Cross-Sectional Area	Conductor			Thickness of Conductor Screen Approx.	Thickness of Insulation	Thickness of Insulation Screen Approx.	Thickness of Lead Sheath	Thickness of Outer Sheath	Outer Diameter of Cable	Weight of Cable	Max. DC Conductor Resistance at 20°C	Capacitance
	Shape	Diameter	mm									
240	Compact Round Stranded	18.1	1.5	16.0	1.3	1.0	4.5	78	6.5	0.0754	0.16	
300		20.4	1.5	16.0	1.3	1.0	4.5	80	7.2	0.0601	0.17	
400		23.2	1.5	16.0	1.3	1.0	4.5	83	8.2	0.0470	0.18	
500		26.3	1.5	16.0	1.3	1.0	4.5	86	9.5	0.0366	0.20	
630		30.2	1.5	16.0	1.3	1.0	4.5	90	11.0	0.0283	0.21	
800	34.0	1.5	16.0	1.3	1.0	4.5	94	13.0	0.0221	0.23		
1000	38.7	1.5	16.0	1.3	1.0	4.5	98	15.5	0.0176	0.25		
1200	Segment Stranded (Miliken)	41.8	1.5	16.0	1.3	1.0	4.5	101	17.2	0.0151	0.27	
1600		48.1	1.5	16.0	1.3	1.0	4.5	108	21.4	0.0113	0.30	
2000		54.3	1.5	16.0	1.3	1.0	4.5	114	25.5	0.0090	0.32	
2500		63.0	1.5	16.0	1.3	1.0	4.5	122	31.2	0.0072	0.36	

36/66 (72.5) kV
64/110 (123) kV
76/132 (145) kV
87/161 (170) kV
127/230 (245) kV
220/400 (420) kV
290/500 (550) kV

4.11 76/132(145)kV with Lead Sheath

Lead Sheath



Construction

- Copper Conductor
- XLPE Insulation
- Lead Sheath
- PE(or PVC or Flame retardant PE) Outer Jacket

Continuous current ratings (load factor=100%) for one circuit in operation (Ampere)

Cross-Sectional Area (mm ²)	Direct Buried	Pipe Duct	In Air	
			Trefoil	Flat (S=2D)
240	523	484	595	659
300	592	547	680	756
400	676	624	785	877
500	770	713	903	1017
630	878	812	1041	1182
800	987	917	1179	1354
1000	1143	1065	1396	1603
1200	1231	1146	1513	1749
1600	1403	1309	1738	2046
2000	1540	1440	1915	2297
2500	1674	1570	2093	2576

Constructional Data (Nominal)

Cross-Sectional Area	Conductor		Thickness of Conductor Screen Approx.	Thickness of Insulation	Thickness of Insulation Screen Approx.	Thickness of Aluminum Sheath	Thickness of Outer Sheath	Outer Diameter of Cable	Weight of Cable	Max. DC Conductor Resistance at 20°C	Capacitance
	Shape	Diameter									
240	Compact Round Stranded	18.1	1.5	16.0	1.3	1.6	4.5	74	9.2	0.0754	0.16
300		20.4	1.5	16.0	1.3	1.6	4.5	77	10.0	0.0601	0.17
400		23.2	1.5	16.0	1.3	1.7	4.5	80	11.4	0.0470	0.18
500		26.3	1.5	16.0	1.3	1.7	4.5	83	12.7	0.0366	0.20
630		30.2	1.5	16.0	1.3	1.8	4.5	87	14.8	0.0283	0.21
800	34.0	1.5	16.0	1.3	1.8	4.5	91	16.9	0.0221	0.23	
1000	38.7	1.5	16.0	1.3	1.9	4.5	95	20.0	0.0176	0.25	
1200	Segment Stranded (Miliken)	41.8	1.5	16.0	1.3	1.9	4.5	98	21.9	0.0151	0.27
1600		48.1	1.5	16.0	1.3	2.0	4.5	105	26.7	0.0113	0.30
2000		54.3	1.5	16.0	1.3	2.1	4.5	111	31.6	0.0090	0.32
2500		63.0	1.5	16.0	1.3	2.3	4.5	120	38.7	0.0072	0.36

4.12 76/132(145)kV with Copper Wire Shield

Copper Wire Shield



Construction

- Copper Conductor
- XLPE Insulation
- Copper wire shield
- PE(or PVC or Flame retardant PE) Outer Jacket

Continuous current ratings (load factor=100%) for one circuit in operation (Ampere)

Cross-Sectional Area (mm ²)	Direct Buried	Pipe Duct	In Air	
			Trefoil	Flat (S=2D)
240	525	492	601	673
300	593	555	688	774
400	675	632	792	896
500	767	716	908	1033
630	872	811	1045	1200
800	979	932	1182	1374
1000	1145	1087	1420	1649
1200	1233	1212	1539	1801
1600	1414	1388	1784	2125
2000	1569	1532	2003	2418
2500	1653	1614	2111	2548

Constructional Data (Nominal)

Cross-Sectional Area	Conductor		Thickness of Conductor Screen Approx.	Thickness of Insulation	Thickness of Insulation Screen Approx.	Diameter & Number of Copper Wires	Thickness of Outer Sheath	Outer Diameter of Cable	Weight of Cable	Max. DC Conductor Resistance at 20°C	Capacitance
	Shape	Diameter									
240	Compact Round Stranded	18.1	1.5	16.0	1.3	1.5 x 80	4.5	70	6.5	0.0754	0.16
300		20.4	1.5	16.0	1.3	1.5 x 80	4.5	72	7.1	0.0601	0.17
400		23.2	1.5	16.0	1.3	1.5 x 80	4.5	75	8.1	0.0470	0.18
500		26.3	1.5	16.0	1.3	1.5 x 80	4.5	80	9.5	0.0366	0.20
630		30.2	1.5	16.0	1.3	1.5 x 80	4.5	84	11.0	0.0283	0.21
800	34.0	1.5	16.0	1.3	1.5 x 80	4.5	88	12.9	0.0221	0.23	
1000	38.7	1.5	16.0	1.3	1.5 x 80	4.5	93	15.3	0.0176	0.25	
1200	Segment Stranded (Miliken)	41.8	1.5	16.0	1.3	1.5 x 80	4.5	96	17.1	0.0151	0.27
1600		48.1	1.5	16.0	1.3	1.5 x 80	4.5	102	21.2	0.0113	0.30
2000		54.3	1.5	16.0	1.3	1.5 x 80	4.5	110	25.8	0.0090	0.32
2500		63.0	1.5	16.0	1.3	1.5 x 80	4.5	118	31.4	0.0072	0.36

4.13 87/161(170)kV with Corrugated Aluminum Sheath

Corrugated Aluminum Sheath



Construction

- Copper Conductor
- XLPE Insulation
- Al sheath
- PE(or PVC or Flame retardant PE) Outer Jacket

Continuous current ratings (load factor=100%) for one circuit in operation (Ampere)

Cross-Sectional Area (mm ²)	Direct Buried	Pipe Duct	In Air	
			Trefoil	Flat (S=2D)
300	584	558	669	740
400	664	634	768	855
500	754	718	879	988
630	853	811	1009	1146
800	953	938	1134	1307
1000	1100	1087	1328	1548
1200	1179	1163	1429	1684
1600	1331	1311	1627	1967
2000	1447	1485	1774	2199
2500	1523	1563	1868	2315

Constructional Data (Nominal)

Cross-Sectional Area	Conductor			Thickness of Conductor Screen Approx.	Thickness of Insulation	Thickness of Insulation Screen Approx.	Thickness of Lead Sheath	Thickness of Outer Sheath	Outer Diameter of Cable	Weight of Cable	Max. DC Conductor Resistance at 20°C	Capacitance
	Shape	Diameter	mm									
300	Compact Round Stranded	20.4	1.5	17	1.3	1.9	4.5	87	8.4	0.0601	0.16	
400		23.2	1.5	17	1.3	1.9	4.5	91	9.4	0.0470	0.18	
500		26.3	1.5	17	1.3	2.0	4.5	94	10.7	0.0366	0.19	
630		30.2	1.5	17	1.3	2.1	4.5	98	12.3	0.0283	0.21	
800		34.0	1.5	17	1.3	2.2	4.5	102	14.4	0.0221	0.22	
1000	Segment Stranded (Milliken)	38.7	1.5	17	1.3	2.3	4.5	108	17.0	0.0176	0.24	
1200		41.8	1.5	17	1.3	2.3	4.5	111	19.0	0.0151	0.26	
1600		48.1	1.5	17	1.3	2.5	4.5	119	23.5	0.0113	0.28	
2000		54.3	1.5	17	1.3	2.6	4.5	125	28.0	0.0090	0.31	
2500		63.0	1.5	17	1.3	2.8	4.5	134	34.5	0.0072	0.34	

4.14 87/161(170)kV with Smooth Welded Aluminum Sheath

Smooth Welded Aluminum Sheath



Construction

- Copper Conductor
- XLPE Insulation
- Smooth welded Al Sheath
- PE(or Flame retardant PE) Outer Jacket

Continuous current ratings (load factor=100%) for one circuit in operation (Ampere)

Cross-Sectional Area (mm ²)	Direct Buried	Pipe Duct	In Air	
			Trefoil	Flat (S=2D)
240	518	480	581	648
300	584	543	661	742
400	665	617	757	859
500	755	703	864	992
630	856	796	984	1150
800	958	893	1101	1312
1000	1099	1027	1274	1542
1200	1176	1099	1362	1676
1600	1323	1239	1525	1945
2000	1436	1347	1646	2167
2500	1544	1451	1765	2410

Constructional Data (Nominal)

Cross-Sectional Area	Conductor			Thickness of Conductor Screen Approx.	Thickness of Insulation	Thickness of Insulation Screen Approx.	Thickness of Lead Sheath	Thickness of Outer Sheath	Outer Diameter of Cable	Weight of Cable	Max. DC Conductor Resistance at 20°C	Capacitance
	Shape	Diameter	mm									
240	Compact Round Stranded	18.1	1.5	17	1.3	1.1	4.5	79	6.8	0.0754	0.15	
300		20.4	1.5	17	1.3	1.1	4.5	83	7.5	0.0601	0.16	
400		23.2	1.5	17	1.3	1.1	4.5	85	8.5	0.0470	0.18	
500		26.3	1.5	17	1.3	1.1	4.5	89	9.8	0.0366	0.19	
630		30.2	1.5	17	1.3	1.1	4.5	92	11.4	0.0283	0.21	
800	Segment Stranded (Milliken)	34.0	1.5	17	1.3	1.1	4.5	96	13.4	0.0221	0.22	
1000		38.7	1.5	17	1.3	1.1	4.5	101	15.9	0.0176	0.24	
1200		41.8	1.5	17	1.3	1.1	4.5	104	17.6	0.0151	0.26	
1600		48.1	1.5	17	1.3	1.1	4.5	110	21.8	0.0113	0.28	
2000		54.3	1.5	17	1.3	1.1	4.5	116	26.0	0.0090	0.31	
2500	63.0	1.5	17	1.3	1.1	4.5	125	31.7	0.0072	0.34		

4.15 87/161(170)kV with Lead Sheath

Lead Sheath



Construction

- Copper Conductor
- XLPE Insulation
- Lead Sheath
- PE(or PVC or Flame retardant PE) Outer Jacket

Continuous current ratings (load factor=100%) for one circuit in operation (Ampere)

Cross-Sectional Area (mm ²)	Direct Buried	Pipe Duct	In Air	
			Trefoil	Flat (S=2D)
240	522	483	593	656
300	591	546	678	752
400	674	626	782	872
500	768	712	901	1011
630	876	814	1038	1175
800	985	915	1176	1345
1000	1141	1062	1391	1592
1200	1228	1147	1506	1736
1600	1399	1311	1731	2031
2000	1535	1441	1907	2280
2500	1670	1570	2084	2556

Constructional Data (Nominal)

Cross-Sectional Area	Conductor		Thickness of Conductor Screen Approx.	Thickness of Insulation	Thickness of Insulation Screen Approx.	Thickness of Aluminum Sheath	Thickness of Outer Sheath	Outer Diameter of Cable	Weight of Cable	Max. DC Conductor Resistance at 20°C	Capacitance
	Shape	Diameter									
240	Compact Round Stranded	18.1	1.5	17	1.3	1.7	4.5	76	9.6	0.0754	0.15
300		20.4	1.5	17	1.3	1.7	4.5	80	10.7	0.0601	0.16
400		23.2	1.5	17	1.3	1.7	4.5	82	11.8	0.0470	0.18
500		26.3	1.5	17	1.3	1.8	4.5	86	13.5	0.0366	0.19
630		30.2	1.5	17	1.3	1.8	4.5	90	15.3	0.0283	0.21
800	34.0	1.5	17	1.3	1.8	4.5	93	17.5	0.0221	0.22	
1000	38.7	1.5	17	1.3	1.9	4.5	98	20.5	0.0176	0.24	
1200	Segment Stranded (Miliken)	41.8	1.5	17	1.3	1.9	4.5	101	22.4	0.0151	0.26
1600		48.1	1.5	17	1.3	2.0	4.5	108	27.3	0.0113	0.28
2000		54.3	1.5	17	1.3	2.1	4.5	114	32.2	0.0090	0.31
2500		63.0	1.5	17	1.3	2.3	4.5	123	39.3	0.0072	0.34

4.16 87/161(170)kV with Copper Wire Shield

Copper Wire Shield



Construction

- Copper Conductor
- XLPE Insulation
- Copper wire shield
- PE(or PVC or Flame retardant PE) Outer Jacket

Continuous current ratings (load factor=100%) for one circuit in operation (Ampere)

Cross-Sectional Area (mm ²)	Direct Buried	Pipe Duct	In Air	
			Trefoil	Flat (S=2D)
300	591	553	684	765
400	673	629	789	887
500	766	713	907	1027
630	871	829	1043	1193
800	977	928	1181	1367
1000	1143	1081	1415	1639
1200	1232	1208	1535	1790
1600	1404	1382	1765	2100
2000	1554	1523	1973	2384
2500	1636	1603	2077	2510

Constructional Data (Nominal)

Cross-Sectional Area	Conductor		Thickness of Conductor Screen Approx.	Thickness of Insulation	Thickness of Insulation Screen Approx.	Diameter & Number of Copper Wires	Thickness of Outer Sheath	Outer Diameter of Cable	Weight of Cable	Max. DC Conductor Resistance at 20°C	Capacitance
	Shape	Diameter									
300	Compact Round Stranded	20.4	1.5	17	1.3	1.5 x 80	4.5	76	7.6	0.0601	0.16
400		23.2	1.5	17	1.3	1.5 x 80	4.5	79	8.5	0.0470	0.18
500		26.3	1.5	17	1.3	1.5 x 80	4.5	82	9.7	0.0366	0.19
630		30.2	1.5	17	1.3	1.5 x 80	4.5	86	11.3	0.0283	0.21
800		34.0	1.5	17	1.3	1.5 x 80	4.5	90	13.2	0.0221	0.22
1000	38.7	1.5	17	1.3	1.5 x 80	4.5	95	15.5	0.0176	0.24	
1200	41.8	1.5	17	1.3	1.5 x 80	4.5	98	17.4	0.0151	0.26	
1600	Segment Stranded (Miliken)	48.1	1.5	17	1.3	1.5 x 80	4.5	104	21.5	0.0113	0.28
2000		54.3	1.5	17	1.3	1.5 x 80	4.5	110	25.6	0.0090	0.31
2500		63.0	1.5	17	1.3	1.5 x 80	4.5	118	31.1	0.0072	0.34

4.17 127/230(245)kV with Corrugated Aluminum Sheath

Corrugated Aluminum Sheath



Construction

- Copper Conductor
- XLPE Insulation
- Al sheath
- PE(or PVC or Flame retardant PE) Outer Jacket

Continuous current ratings (load factor=100%) for one circuit in operation (Ampere)

Cross-Sectional Area (mm ²)	Direct Buried	Pipe Duct	In Air	
			Trefoil	Flat (S=2D)
400	661	621	750	849
500	749	703	851	980
630	848	797	964	1133
800	946	891	1072	1291
1000	1079	1015	1222	1512
1200	1151	1085	1297	1640
1600	1290	1217	1438	1896
2000	1395	1319	1540	2109
2500	1500	1420	1641	2344

Constructional Data (Nominal)

Cross-Sectional Area	Conductor		Thickness of Conductor Screen Approx.	Thickness of Insulation	Thickness of Insulation Screen Approx.	Thickness of Lead Sheath	Thickness of Outer Sheath	Outer Diameter of Cable	Weight of Cable	Max. DC Conductor Resistance at 20°C	Capacitance
	Shape	Diameter									
400	Compact Round Stranded	23.2	1.5	20.0	1.3	2.2	4.5	102	10.9	0.0470	0.16
500		26.3	1.5	20.0	1.3	2.3	4.5	106	12.3	0.0366	0.17
630		30.2	1.5	20.0	1.3	2.3	4.5	110	14.0	0.0283	0.18
800		34.0	1.5	20.0	1.3	2.4	4.5	114	16.2	0.0221	0.20
1000	Segment Stranded (Miliken)	38.7	1.5	20.0	1.3	2.5	4.5	119	18.9	0.0176	0.21
1200		41.8	1.5	20.0	1.3	2.6	4.5	122	20.8	0.0151	0.22
1600		48.1	1.5	20.0	1.3	2.7	4.5	129	25.3	0.0113	0.25
2000		54.3	1.5	20.0	1.3	2.8	4.5	135	29.8	0.0090	0.27
2500		63.0	1.5	20.0	1.3	3.0	4.5	145	36.1	0.0072	0.30

4.18 127/230(245)kV with Smooth Welded Aluminum Sheath

Smooth Welded Aluminum Sheath



Construction

- Copper Conductor
- XLPE Insulation
- Smooth welded Al Sheath
- PE(or Flame retardant PE) Outer Jacket

Continuous current ratings (load factor=100%) for one circuit in operation (Ampere)

Cross-Sectional Area (mm ²)	Direct Buried	Pipe Duct	In Air	
			Trefoil	Flat (S=2D)
400	660	615	751	847
500	749	700	857	979
630	849	792	975	1133
800	949	888	1091	1292
1000	1087	1016	1260	1518
1200	1164	1090	1347	1649
1600	1308	1228	1508	1913
2000	1419	1335	1629	2131
2500	1525	1437	1747	2370

Constructional Data (Nominal)

Cross-Sectional Area	Conductor		Thickness of Conductor Screen Approx.	Thickness of Insulation	Thickness of Insulation Screen Approx.	Thickness of Lead Sheath	Thickness of Outer Sheath	Outer Diameter of Cable	Weight of Cable	Max. DC Conductor Resistance at 20°C	Capacitance
	Shape	Diameter									
400	Compact Round Stranded	23.2	1.5	20.0	1.3	1.2	4.5	91	9.3	0.0470	0.16
500		26.3	1.5	20.0	1.3	1.2	4.5	95	10.6	0.0366	0.17
630		30.2	1.5	20.0	1.3	1.2	4.5	98	12.2	0.0283	0.18
800		34.0	1.5	20.0	1.3	1.2	4.5	102	14.3	0.0221	0.20
1000	Segment Stranded (Miliken)	38.7	1.5	20.0	1.3	1.2	4.5	107	16.8	0.0176	0.21
1200		41.8	1.5	20.0	1.3	1.2	4.5	110	18.5	0.0151	0.22
1600		48.1	1.5	20.0	1.3	1.2	4.5	116	22.8	0.0113	0.25
2000		54.3	1.5	20.0	1.3	1.2	4.5	122	27.0	0.0090	0.27
2500		63.0	1.5	20.0	1.3	1.2	4.5	131	32.8	0.0072	0.30

36/66 (72.5) kV
 64/110 (123) kV
 76/132 (145) kV
 87/161 (170) kV
 127/230 (245) kV
 220/400 (420) kV
 290/500 (550) kV

4.19 127/230(245)kV with Lead Sheath

Lead Sheath



Construction

- Copper Conductor
- XLPE Insulation
- Lead Sheath
- PE(or PVC or Flame retardant PE) Outer Jacket

Continuous current ratings (load factor=100%) for one circuit in operation (Ampere)

Cross-Sectional Area (mm ²)	Direct Buried	Pipe Duct	In Air	
			Trefoil	Flat (S=2D)
400	669	624	776	860
500	762	710	893	996
630	869	811	1028	1157
800	977	911	1165	1324
1000	1130	1056	1376	1565
1200	1216	1136	1488	1707
1600	1385	1301	1708	1994
2000	1518	1424	1881	2237
2500	1649	1555	2054	2506

Constructional Data (Nominal)

Cross-Sectional Area	Conductor			Thickness of Conductor Screen Approx.	Thickness of Insulation	Thickness of Insulation Screen Approx.	Thickness of Aluminum Sheath	Thickness of Outer Sheath	Outer Diameter of Cable	Weight of Cable	Max. DC Conductor Resistance at 20°C	Capacitance
	Shape	Diameter	mm									
400	Compact Round Stranded	23.2	1.5	20.0	1.3	1.8	4.5	88	13.2	0.0470	0.16	
500		26.3	1.5	20.0	1.3	1.8	4.5	92	14.6	0.0366	0.17	
630		30.2	1.5	20.0	1.3	1.9	4.5	96	16.8	0.0283	0.18	
800		34.0	1.5	20.0	1.3	1.9	4.5	99	19.0	0.0221	0.20	
1000	Segment Stranded (Miliken)	38.7	1.5	20.0	1.3	1.9	4.5	104	21.8	0.0176	0.21	
1200		41.8	1.5	20.0	1.3	2.0	4.5	107	24.0	0.0151	0.22	
1600		48.1	1.5	20.0	1.3	2.1	4.5	114	29.0	0.0113	0.25	
2000		54.3	1.5	20.0	1.3	2.2	4.5	120	34.1	0.0090	0.27	
2500		63.0	1.5	20.0	1.3	2.4	4.5	129	41.3	0.0072	0.30	

4.20 127/230(245)kV with Copper Wire Shield

Copper Wire Shield



Construction

- Copper Conductor
- XLPE Insulation
- Copper wire shield
- PE(or PVC or Flame retardant PE) Outer Jacket

Continuous current ratings (load factor=100%) for one circuit in operation (Ampere)

Cross-Sectional Area (mm ²)	Direct Buried	Pipe Duct	In Air	
			Trefoil	Flat (S=2D)
400	672	624	785	867
500	766	713	906	1005
630	874	815	1047	1168
800	984	918	1191	1338
1000	1141	1067	1418	1584
1200	1231	1150	1543	1729
1600	1409	1319	1795	2026
2000	1553	1457	2003	2280
2500	1702	1600	2231	2567

Constructional Data (Nominal)

Cross-Sectional Area	Conductor			Thickness of Conductor Screen Approx.	Thickness of Insulation	Thickness of Insulation Screen Approx.	Diameter & Number of Copper Wires	Thickness of Outer Sheath	Outer Diameter of Cable	Weight of Cable	Max. DC Conductor Resistance at 20°C	Capacitance
	Shape	Diameter	mm									
400	Compact Round Stranded	23.2	1.5	20.0	1.3	1.5 x 80	4.5	87	9.4	0.0470	0.16	
500		26.3	1.5	20.0	1.3	1.5 x 80	4.5	90	10.6	0.0366	0.17	
630		30.2	1.5	20.0	1.3	1.5 x 80	4.5	94	12.3	0.0283	0.18	
800		34.0	1.5	20.0	1.3	1.5 x 80	4.5	98	14.2	0.0221	0.20	
1000	Segment Stranded (Miliken)	38.7	1.5	20.0	1.3	1.5 x 80	4.5	102	16.7	0.0176	0.21	
1200		41.8	1.5	20.0	1.3	1.5 x 80	4.5	105	18.4	0.0151	0.22	
1600		48.1	1.5	20.0	1.3	1.5 x 80	4.5	112	22.5	0.0113	0.25	
2000		54.3	1.5	20.0	1.3	1.5 x 80	4.5	118	26.7	0.0090	0.27	
2500		63.0	1.5	20.0	1.3	1.5 x 80	4.5	126	32.4	0.0072	0.30	

4.21 220/400(420)kV with Corrugated Aluminum Sheath

Corrugated Aluminum Sheath



Construction

- Copper Conductor
- XLPE Insulation
- Al sheath
- PE(or PVC or Flame retardant PE) Outer Jacket

Continuous current ratings (load factor=100%) for one circuit in operation (Ampere)

Cross-Sectional Area (mm ²)	Direct Buried	Pipe Duct	In Air	
			Trefoil	Flat (S=2D)
630	824	781	937	1090
800	919	869	1043	1241
1000	1048	992	1188	1452
1200	1119	1058	1265	1575
1600	1254	1187	1405	1822
2000	1359	1288	1511	2028
2500	1465	1393	1621	2255
3000	1548	1474	1701	2433

Constructional Data (Nominal)

Cross-Sectional Area	Conductor		Thickness of Conductor Screen Approx.	Thickness of Insulation	Thickness of Insulation Screen Approx.	Thickness of Lead Sheath	Thickness of Outer Sheath	Outer Diameter of Cable	Weight of Cable	Max. DC Conductor Resistance at 20°C	Capacitance
	Shape	Diameter									
630	Compact Round Stranded	30.2	1.7	26.0	1.7	2.6	6	127	17.4	0.0283	0.15
800		34.0	1.7	26.0	1.7	2.7	6	132	19.7	0.0221	0.17
1000	Segment Stranded (Miliken)	38.7	1.7	26.0	1.7	2.8	6	136	22.6	0.0176	0.18
1200		41.8	1.7	26.0	1.7	2.8	6	139	24.4	0.0151	0.19
1600		48.1	1.7	26.0	1.7	3.0	6	146	29.3	0.0113	0.20
2000		54.3	1.7	26.0	1.7	3.1	6	153	34.0	0.0090	0.22
2500		63.0	1.7	26.0	1.7	3.2	6	164	40.5	0.0072	0.24
3000		69.0	1.7	26.0	1.7	3.4	6	171	46.0	0.0060	0.26

4.22 220/400(420)kV with Smooth Welded Aluminum Sheath

Smooth Welded Aluminum Sheath



Construction

- Copper Conductor
- XLPE Insulation
- Smooth welded Al Sheath
- PE(or Flame retardant PE) Outer Jacket

Continuous current ratings (load factor=100%) for one circuit in operation (Ampere)

Cross-Sectional Area (mm ²)	Direct Buried	Pipe Duct	In Air	
			Trefoil	Flat (S=2D)
400	660	615	751	847
500	749	700	857	979
630	849	792	975	1133
800	949	888	1091	1292
1000	1087	1016	1260	1518
1200	1164	1090	1347	1649
1600	1308	1228	1508	1913
2000	1419	1335	1629	2131
2500	1525	1437	1747	2370

Constructional Data (Nominal)

Cross-Sectional Area	Conductor		Thickness of Conductor Screen Approx.	Thickness of Insulation	Thickness of Insulation Screen Approx.	Thickness of Lead Sheath	Thickness of Outer Sheath	Outer Diameter of Cable	Weight of Cable	Max. DC Conductor Resistance at 20°C	Capacitance
	Shape	Diameter									
400	Compact Round Stranded	23.2	1.5	20.0	1.3	1.2	4.5	91	9.3	0.0470	0.16
500		26.3	1.5	20.0	1.3	1.2	4.5	95	10.6	0.0366	0.17
630		30.2	1.5	20.0	1.3	1.2	4.5	98	12.2	0.0283	0.18
800		34.0	1.5	20.0	1.3	1.2	4.5	102	14.3	0.0221	0.20
1000		38.7	1.5	20.0	1.3	1.2	4.5	107	16.8	0.0176	0.21
1200		41.8	1.5	20.0	1.3	1.2	4.5	110	18.5	0.0151	0.22
1600		Segment Stranded (Miliken)	48.1	1.5	20.0	1.3	1.2	4.5	116	22.8	0.0113
2000	54.3		1.5	20.0	1.3	1.2	4.5	122	27.0	0.0090	0.27
2500	63.0		1.5	20.0	1.3	1.2	4.5	131	32.8	0.0072	0.30

36/66 (72.5) kV
64/110 (123) kV
76/132 (145) kV
87/161 (170) kV
127/230 (245) kV
220/400 (420) kV
290/500 (550) kV

4.23 220/400(420)kV with Lead Sheath

Lead Sheath



Construction

- Copper Conductor
- XLPE Insulation
- Lead Sheath
- PE(or PVC or Flame retardant PE) Outer Jacket

Continuous current ratings (load factor=100%) for one circuit in operation (Ampere)

Cross-Sectional Area (mm ²)	Direct Buried	Pipe Duct	In Air	
			Trefoil	Flat (S=2D)
630	844	793	1000	1111
800	949	892	1132	1270
1000	1094	1031	1329	1497
1200	1176	1107	1436	1631
1600	1336	1259	1645	1902
2000	1462	1380	1810	2130
2500	1584	1496	1973	2381
3000	1674	1584	2087	2573

Constructional Data (Nominal)

Cross-Sectional Area	Conductor		Thickness of Conductor Screen Approx.	Thickness of Insulation	Thickness of Insulation Screen Approx.	Thickness of Aluminum Sheath	Thickness of Outer Sheath	Outer Diameter of Cable	Weight of Cable	Max. DC Conductor Resistance at 20°C	Capacitance
	Shape	Diameter									
630	Compact Round	30.2	1.7	26.0	1.7	2.0	6.0	112	20.4	0.0283	0.15
800		Stranded	34.0	1.7	26.0	1.7	2.1	6.0	116	23.1	0.0221
1000	Segment Stranded (Miliken)	38.7	1.7	26.0	1.7	2.2	6.0	121	26.4	0.0176	0.18
1200		41.8	1.7	26.0	1.7	2.3	6.0	124	28.8	0.0151	0.19
1600		48.1	1.7	26.0	1.7	2.4	6.0	131	34.1	0.0113	0.20
2000		54.3	1.7	26.0	1.7	2.5	6.0	137	39.4	0.0090	0.22
2500		63.0	1.7	26.0	1.7	2.7	6.0	146	47.0	0.0072	0.24
3000		69.0	1.7	26.0	1.7	2.9	6.0	152	53.6	0.0060	0.26

4.24 220/400(420)kV with Copper Wire Shield

Copper Wire Shield



Construction

- Copper Conductor
- XLPE Insulation
- Copper wire shield
- PE(or PVC or Flame retardant PE) Outer Jacket

Continuous current ratings (load factor=100%) for one circuit in operation (Ampere)

Cross-Sectional Area (mm ²)	Direct Buried	Pipe Duct	In Air	
			Trefoil	Flat (S=2D)
630	850	798	1019	1121
800	957	900	1160	1282
1000	1108	1040	1374	1514
1200	1194	1124	1494	1651
1600	1364	1286	1737	1932
2000	1502	1418	1939	2171
2500	1643	1553	2159	2440
3000	1754	1661	2328	2650

Constructional Data (Nominal)

Cross-Sectional Area	Conductor		Thickness of Conductor Screen Approx.	Thickness of Insulation	Thickness of Insulation Screen Approx.	Diameter & Number of Copper Wires	Thickness of Outer Sheath	Outer Diameter of Cable	Weight of Cable	Max. DC Conductor Resistance at 20°C	Capacitance
	Shape	Diameter									
630	Compact Round	30.2	1.7	26.0	1.7	1.7 x 80	6.0	111	15.0	0.0283	0.15
800		Stranded	34.0	1.7	26.0	1.7	1.7 x 80	6.0	114	17.0	0.0221
1000	Segment Stranded (Miliken)	38.7	1.7	26.0	1.7	1.7 x 80	6.0	119	19.6	0.0176	0.18
1200		41.8	1.7	26.0	1.7	1.7 x 80	6.0	122	21.4	0.0151	0.19
1600		48.1	1.7	26.0	1.7	1.7 x 80	6.0	128	25.7	0.0113	0.20
2000		54.3	1.7	26.0	1.7	1.7 x 80	6.0	134	30.0	0.0090	0.22
2500		63.0	1.7	26.0	1.7	1.7 x 80	6.0	143	35.9	0.0072	0.24
3000		69.0	1.7	26.0	1.7	1.7 x 80	6.0	149	40.8	0.0060	0.26

4.25 290/500(550)kV with Corrugated Aluminum Sheath

Corrugated Aluminum Sheath



Construction

- Copper Conductor
- XLPE Insulation
- Al sheath
- PE(or PVC or Flame retardant PE) Outer Jacket

Continuous current ratings (load factor=100%) for one circuit in operation (Ampere)

Cross-Sectional Area (mm ²)	Direct Buried	Pipe Duct	In Air	
			Trefoil	Flat (S=2D)
800	910	890	1080	1221
1000	1052	1036	1270	1447
1200	1128	1110	1361	1565
1600	1281	1284	1555	1825
2000	1400	1400	1700	2050
2500	1470	1470	1785	2150
3000	1560	1558	1895	2280

Constructional Data (Nominal)

Cross-Sectional Area	Conductor			Thickness of Conductor Screen Approx.	Thickness of Insulation	Thickness of Insulation Screen Approx.	Thickness of Lead Sheath	Thickness of Outer Sheath	Outer Diameter of Cable	Weight of Cable	Max. DC Conductor Resistance at 20°C	Capacitance
	Shape	Diameter	mm									
800	Compact Round Stranded	34.0	2.5	34.0	2.0	3.0	6	148	24.6	0.0221	0.14	
1000		38.7	2.5	32.0	2.0	3.0	6	146	26.2	0.0176	0.16	
1200		41.8	2.0	32.0	2.0	3.0	6	150	28.5	0.0151	0.16	
1600	Segment Stranded (Miliken)	48.1	2.0	30.0	2.0	3.1	6	153	32.1	0.0113	0.19	
2000		54.3	2.0	30.0	2.0	3.2	6	158	36.8	0.0090	0.20	
2500		63.0	2.0	30.0	2.0	3.3	6	168	43.6	0.0072	0.23	
3000		69.0	2.0	30.0	2.0	3.5	6	178	48.8	0.0060	0.24	

4.26 290/500(550)kV with Smooth Welded Aluminum Sheath

Smooth Welded Aluminum Sheath



Construction

- Copper Conductor
- XLPE Insulation
- Smooth welded Al Sheath
- PE(or Flame retardant PE) Outer Jacket

Continuous current ratings (load factor=100%) for one circuit in operation (Ampere)

Cross-Sectional Area (mm ²)	Direct Buried	Pipe Duct	In Air	
			Trefoil	Flat (S=2D)
800	904	857	1039	1201
1000	1031	975	1196	1413
1200	1103	1042	1281	1536
1600	1235	1167	1439	1788
2000	1337	1265	1556	1991
2500	1433	1356	1671	2211
3000	1505	1426	1753	2380

Constructional Data (Nominal)

Cross-Sectional Area	Conductor			Thickness of Conductor Screen Approx.	Thickness of Insulation	Thickness of Insulation Screen Approx.	Thickness of Lead Sheath	Thickness of Outer Sheath	Outer Diameter of Cable	Weight of Cable	Max. DC Conductor Resistance at 20°C	Capacitance
	Shape	Diameter	mm									
800	Compact Round Stranded	34.0	2.5	34.0	2.0	1.3	6	137	20.3	0.0221	0.14	
1000		38.7	2.5	32.0	2.0	1.3	6	137	22.3	0.0176	0.16	
1200		41.8	2.0	32.0	2.0	1.3	6	139	24.0	0.0151	0.16	
1600	Segment Stranded (Miliken)	48.1	2.0	30.0	2.0	1.3	6	142	27.7	0.0113	0.19	
2000		54.3	2.0	30.0	2.0	1.3	6	148	32.1	0.0090	0.20	
2500		63.0	2.0	30.0	2.0	1.3	6	156	38.2	0.0072	0.23	
3000		69.0	2.0	30.0	2.0	1.3	6	162	43.4	0.0060	0.24	

36/66 (72.5) kV
64/110 (123) kV
76/132 (145) kV
87/161 (170) kV
127/230 (245) kV
220/400 (420) kV
290/500 (550) kV

4.27 290/500(550)kV with Lead Sheath

Lead Sheath



Construction

- Copper Conductor
- XLPE Insulation
- Lead Sheath
- PE(or PVC or Flame retardant PE) Outer Jacket

Continuous current ratings (load factor=100%) for one circuit in operation (Ampere)

Cross-Sectional Area (mm ²)	Direct Buried	Pipe Duct	In Air	
			Trefoil	Flat (S=2D)
800	931	883	1103	1225
1000	1070	1013	1293	1449
1200	1151	1089	1399	1580
1600	1303	1229	1605	1852
2000	1424	1344	1764	2072
2500	1539	1458	1921	2314
3000	1630	1546	2041	2502

Constructional Data (Nominal)

Cross-Sectional Area	Conductor		Thickness of Conductor Screen Approx.	Thickness of Insulation	Thickness of Insulation Screen Approx.	Thickness of Lead Sheath	Thickness of Outer Sheath	Outer Diameter of Cable	Weight of Cable	Max. DC Conductor Resistance at 20°C	Capacitance
	Shape	Diameter									
mm ²		mm	mm	mm	mm	mm	mm	mm	kg/m	Ω/km	μF/km
800	Compact Round Stranded	34.0	2.5	34.0	2.0	2.5	6	135	29.4	0.0221	0.14
1000		38.7	2.5	32.0	2.0	2.5	6	135	31.4	0.0176	0.16
1200		41.8	2.0	32.0	2.0	2.5	6	137	33.2	0.0151	0.16
1600	Segment Stranded (Miliken)	48.1	2.0	30.0	2.0	2.6	6	140	37.6	0.0113	0.19
2000		54.3	2.0	30.0	2.0	2.7	6	146	43.0	0.0090	0.20
2500		63.0	2.0	30.0	2.0	2.9	6	155	50.9	0.0072	0.23
3000		69.0	2.0	30.0	2.0	2.9	6	161	56.6	0.0060	0.24

4.28 220/400(420)kV with Copper Wire Shield

Copper Wire Shield



Construction

- Copper Conductor
- XLPE Insulation
- Copper wire shield
- PE(or PVC or Flame retardant PE) Outer Jacket

Continuous current ratings (load factor=100%) for one circuit in operation (Ampere)

Cross-Sectional Area (mm ²)	Direct Buried	Pipe Duct	In Air	
			Trefoil	Flat (S=2D)
800	942	891	1134	1237
1000	1087	1026	1342	1466
1200	1173	1109	1462	1601
1600	1336	1260	1703	1883
2000	1470	1389	1901	2115
2500	1606	1518	2116	2375
3000	1714	1622	2282	2579

Constructional Data (Nominal)

Cross-Sectional Area	Conductor		Thickness of Conductor Screen Approx.	Thickness of Insulation	Thickness of Insulation Screen Approx.	Diameter & Number of Copper Wires	Thickness of Outer Sheath	Outer Diameter of Cable	Weight of Cable	Max. DC Conductor Resistance at 20°C	Capacitance
	Shape	Diameter									
mm ²		mm	mm	mm	mm	mm x No.	mm	mm	kg/m	Ω/km	μF/km
800	Compact Round Stranded	34.0	2.5	34.0	2.0	2.0 x 80	6.0	133	20.9	0.0221	0.14
1000		38.7	2.5	32.0	2.0	2.0 x 80	6.0	133	22.8	0.0176	0.16
1200		41.8	2.0	32.0	2.0	2.0 x 80	6.0	136	24.5	0.0151	0.16
1600	Segment Stranded (Miliken)	48.1	2.0	30.0	2.0	2.0 x 80	6.0	138	28.1	0.0113	0.19
2000		54.3	2.0	30.0	2.0	2.0 x 80	6.0	144	32.5	0.0090	0.20
2500		63.0	2.0	30.0	2.0	2.0 x 80	6.0	153	38.5	0.0072	0.23
3000		69.0	2.0	30.0	2.0	2.0 x 80	6.0	160	43.5	0.0060	0.24

5.00 Correction Factors for Various Laying Conditions

To determine current capacity for the various laying conditions than those indicated on the every tables, multiply table values by the correction factors shown below.

Correction Factors for Various Ambient Air Temperature

Air Temperature (°C)	20°C	25°C	30°C	35°C	40°C	45°C	50°C
Rating Factor	1.2	1.16	1.10	1.05	1.0	0.94	0.88

Correction Factors for Various Ground Temperature

Air Temperature (°C)	15°C	20°C	25°C	30°C	35°C	40°C	45°C
Rating Factor	1.08	1.04	1.0	0.96	.091	0.87	0.83

Correction Factors for Various Thermal Resistivity of Ground

Thermal Resistivity of Soil (°Cm/W)	0.7	1.0	1.2	1.5	2.0	2.5	3.0
Rating Factor	1.14	1.0	0.93	0.84	0.74	0.67	0.61

Correction Factors for Various Depth of Laying

Depth of Laying (m)	Rating Factor
0.50 ~ 0.70	1.09
0.71 ~ 0.90	1.05
0.91 ~ 1.10	1.03
1.11 ~ 1.30	1.01
1.31 ~ 1.50	1.00

6.00 Permissible Short Circuit Currents

The permissible short circuit current of a cable is determined by the maximum permissible conductor temperature and by the duration of the short circuit current. At high peak currents, the dynamic forces between the conductors must be taken into account.

The short circuit capacity of the conductor and metallic shield of a cable are related principally to their heat capacities and are limited by the maximum temperature permitted under short circuit XLPE power are as follow.

From the two graphs, the short circuit capacity of copper or aluminum conductors (based on a temperature rise from 90°C to 250°C) can be determined.

Logarithmic interpolation between the curves will give estimated values for the various duration.

The curves may be used also to determine the amount of conducting material required to carry a known short circuit current for a given duration.

Copper Conductor

According to IEC 60949 curves based on formula

$$I_s = \varepsilon \times 226 \frac{S}{\sqrt{t}} \sqrt{\ln \frac{\theta_f + 234.5}{\theta_i + 234.5}}$$

where,

I_s = Permissible Short Circuit Current (A)

ε = Factor to allow for heat loss into the Adjacent Components

S = Cross-Sectional Area of Conductor (mm²)

t = Duration of Short Circuit (s)

θ_f = Final Temperature (250°C)

θ_i = Initial Temperature (90°C)

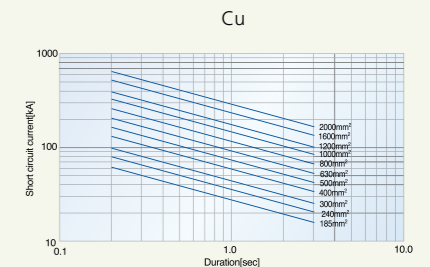

Aluminum Conductor

According to IEC 60949 curves based on formula

$$I_s = \varepsilon \times 148 \frac{S}{\sqrt{t}} \sqrt{\ln \frac{\theta_f + 228}{\theta_i + 228}}$$

where,

I_s = Permissible Short Circuit Current (A)

ε = Factor to allow for heat loss into the Adjacent Components

S = Cross-Sectional Area of Conductor (mm²)

t = Duration of Short Circuit (s)

θ_f = Final Temperature (250°C)

θ_i = Initial Temperature (90°C)

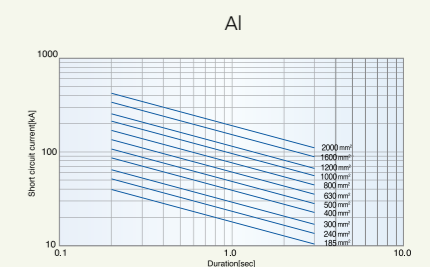

7.01 Outdoor Terminations for 66kV~110kV

7.00 Accessories for EHV Cable Systems

LS Cable & System has developed and manufactured a wide range of terminations and joints for Extra High Voltage(EHV) cable system since 1983. Prefabricated terminations and tape molded joints are installed for 154kV cable system in domestic market. A new advanced accessories, which is called prefabricated and premolded joints, were developed and supplied to many countries in the world. Cable systems from 132kV up to 400kV has been certified through the type test by many international independent institutes (KEMA, CESI, KERI).

Pre-qualification tests for 345kV and 400kV cable systems in accordance with latest IEC standard were carried out successfully by the KEMA and KERI.

- 7.01 Outdoor Terminations for 66kV~110kV
- 7.02 Outdoor Terminations for 132kV~275kV
- 7.03 Outdoor Terminations for 345kV~500kV

- 7.04 SF₆ Gas Insulated Terminations
- 7.05 Oil-Immersed Terminations

- 7.06 Pre-Moulded Joint (PMJ)
- 7.07 Link Box

- 7.08 Transition Joint
- 7.09 Optical Cable & Joint

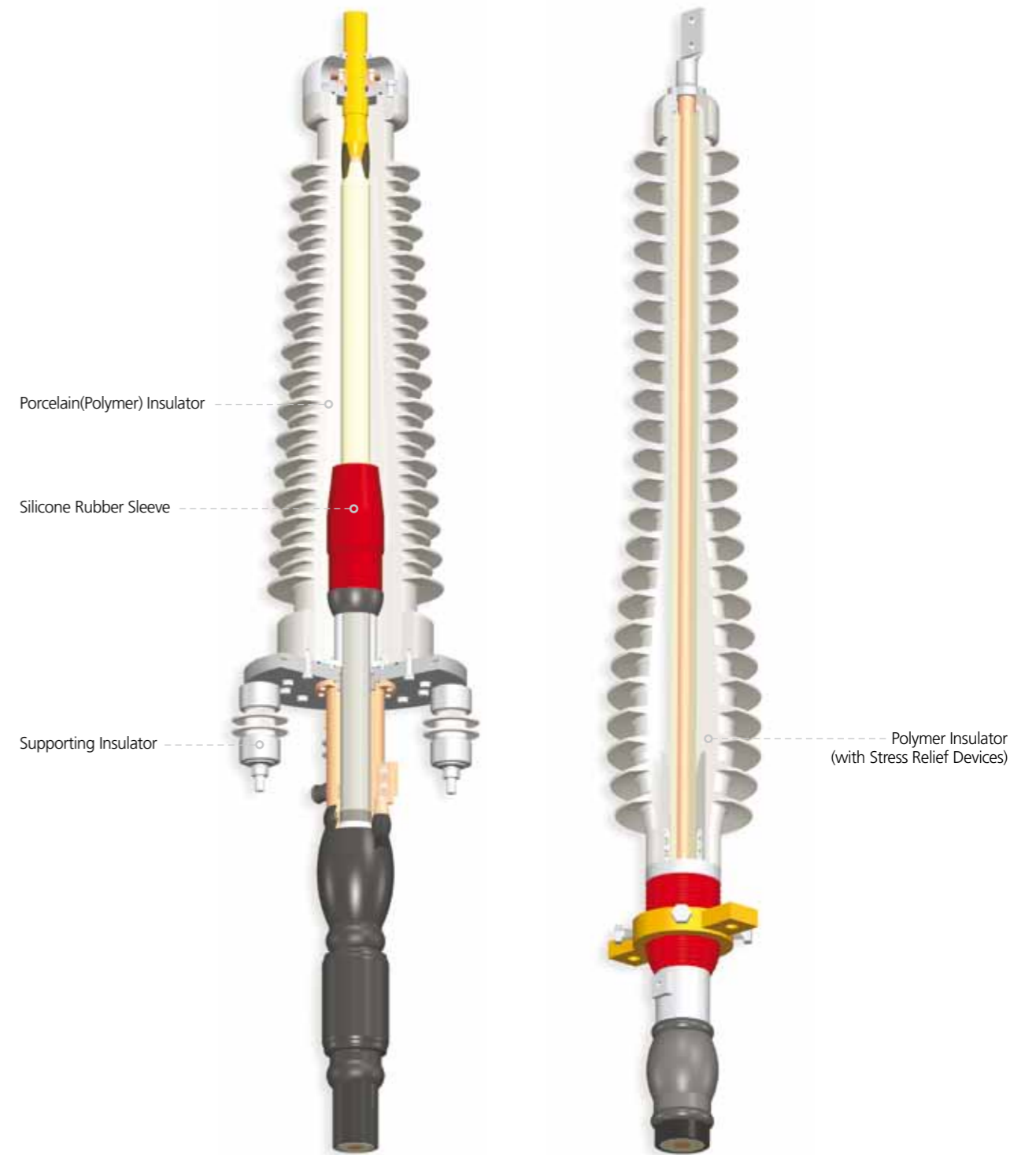

Figure 1

Figure 2

7.02 Outdoor Terminations for 132kV~275kV

The outdoor terminations for 66~110kV are classified on two types. One is based on silicone rubber sleeve (so called Pre-moulded type, Figure1). The other is based on silicone rubber housing (so called dry type, Figure2). Pre-moulded silicone rubber sleeve is designed to fit with controlled interference over the cable insulation and is able to follow the cable's diameter variations still guaranteeing under any service condition a sufficient positive pressure to control the electric field concentration. This uses elastic retention of silicone material itself. The termination is filled with an insulating compound up to a level where the electric field is substantially reduced. The termination base plate and the cable's metallic sheath are electrically insulated



from the supporting structure by means of stand off insulators designed to withstand both mechanical and electrical stresses in services. Upon request of the customer, either porcelain or composite hollow insulator can be supplied. And the insulator can be supplied in brown or grey color. The maximum allowable cable conductor size is 3000mm²(6000kcmil). The latter uses pre-moulded silicone housing with built in sleeve. They completely free from any liquid insulating materials. The high electrical field area of the termination surface covered with skirts.

The housing is whole preformed and can be supplied in grey color. This has advantage like easier installation. The maximum allowable cable conductor size 3000mm²(6000kcmil). The main insulation components are fully examined and tested in the factory.

Rating & Dimension(Based on pre-moulded type)

Max. Voltage	BIL	Max. Height	Max. Weight	Max. Creepage Distance
kV	kV	mm	kg	mm
72.5	325	1000	100	2500
123	550	1500	200	4300

Rating & Dimension(Based on Dry type)

Max. Voltage	BIL	Max. Height	Max. Weight	Max. Creepage Distance
kV	kV	mm	kg	mm
72.5	325	980	100	2500
123	550	1350	200	4300

Selection of insulators with respect to polluted conditions (Based on IEC60815)

Pollution	I (Light)	II (Medium)	III (Heavy)	IV (Very Heavy)
Min. Nominal Specific Creepage Distance	16mm/kV	20mm/kV	25mm/kV	31mm/kV

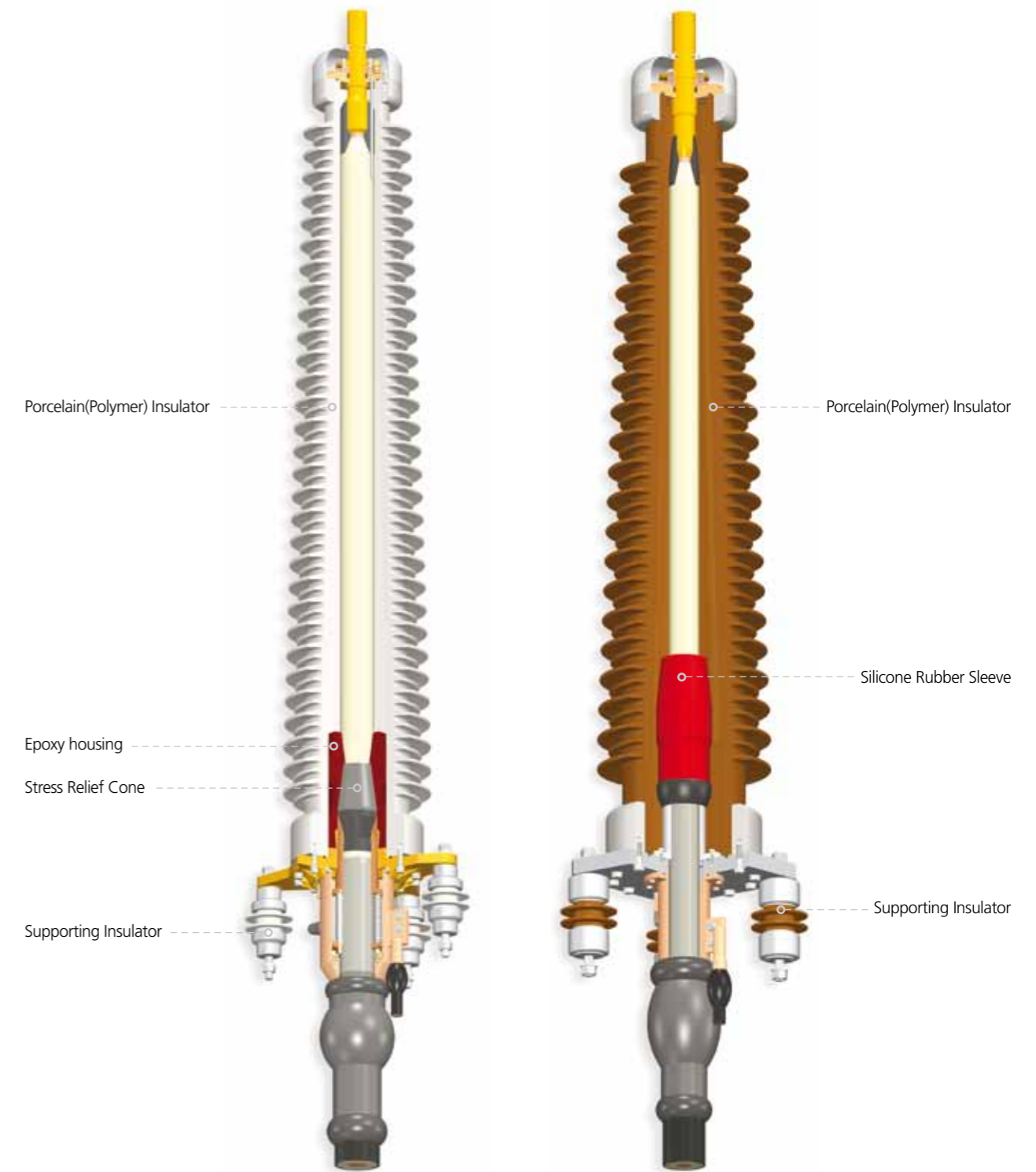

Figure 3

Figure 4

7.03 Outdoor Terminations for 345kV~500kV

The outdoor termination for 132~275kV is classified into two types. One is based on the EPR-based rubber stress relief cone with an epoxy housing (so called pre-fabricated type, figure3). The other is based on the silicone rubber sleeve (so called pre-moulded type, figure4).

The former uses mechanical devices to maintain the interface pressure. The latter uses elastic retention of silicone material itself. Pre-moulded silicone rubber sleeve is designed to fit with controlled interference over the cable insulation and is able to follow the cable's diameter variations still guaranteeing under any service condition a sufficient positive pressure to control the electric field concentration.

The termination base plate and the cable's metallic sheath are electrically insulated from the supporting structure by means of stand off insulators designed to withstand both mechanical and electrical stresses in services. Upon request of the customer, either porcelain or composite hollow insulator can be supplied. And the insulator can be supplied in brown or grey colour. In addition upon request of the customer, arcing horn and shield ring can be supplied. The termination is filled with an insulating compound up to a level where the electric field is substantially reduced. The main insulation components are fully examined and tested in the factory. The maximum allowable cable conductor size is 3000mm²(6000kcmil).



Rating & Dimension(Based on pre-moulded type)

Max. Voltage kV	BIL kV	Max. Height mm	Max. Weight kg	Max. Creepage Distance mm
145	650	2410	700	5000
170	750	2410	800	6000
275	1050	3500	900	8400

Selection of insulators with respect to polluted conditions (Based on IEC60815)

Pollution	I (Light)	II (Medium)	III (Heavy)	IV (Very Heavy)
Min. Nominal Specific Creepage Distance	16mm/kV	20mm/kV	25mm/kV	31mm/kV

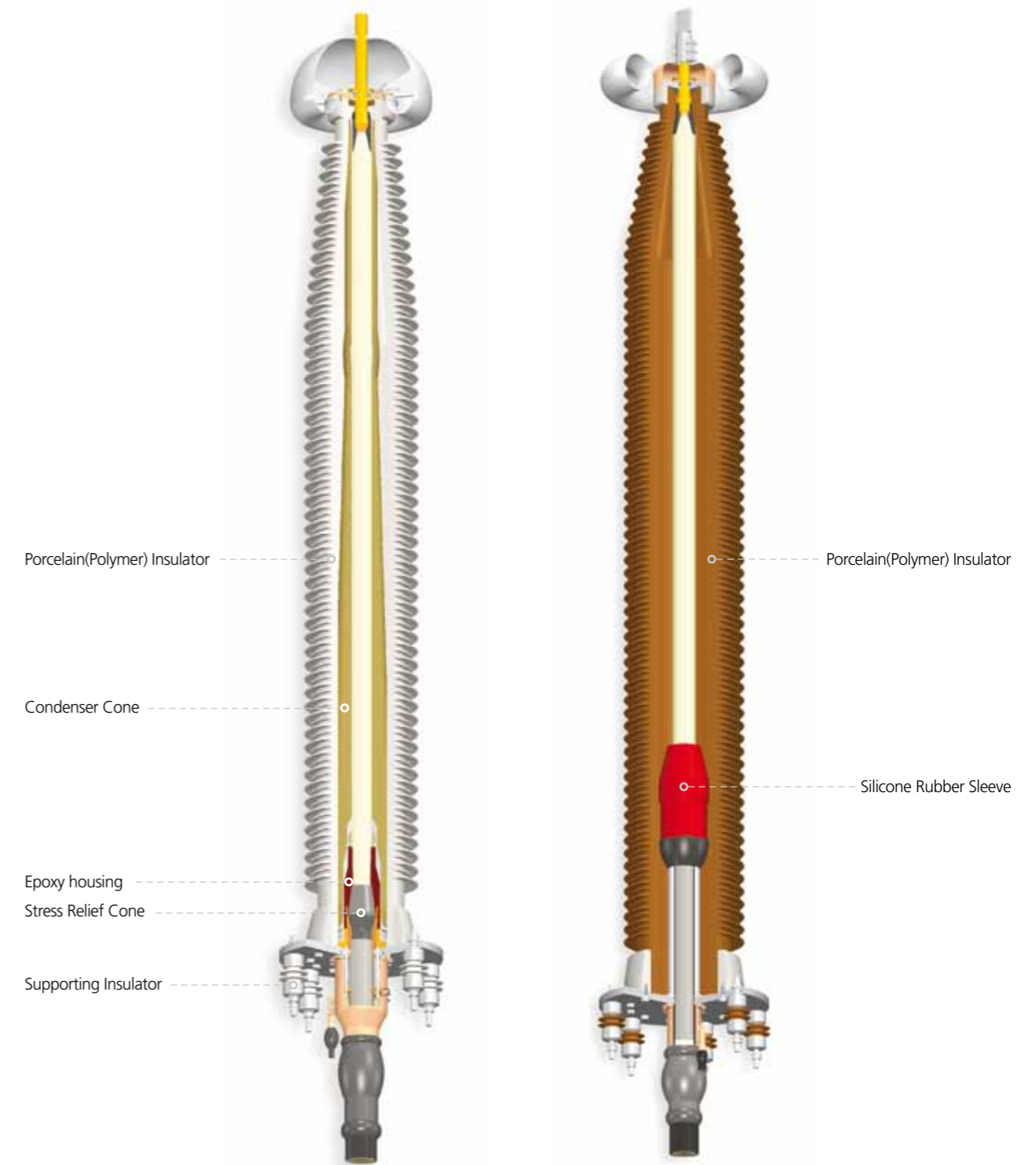

Figure 5

Figure 6

7.04 SF₆ Gas Insulated Terminations

The outdoor termination for 345~500kV is classified into two types. One is based on the EPR-based stress relief cone with the epoxy housing and the oil-impregnated cylindrical capacitor cone is added to secure the uniform longitudinal voltage distribution all along the termination (so called condenser cone type, figure 5). The other is based on silicone rubber sleeve (so called pre-moulded type, figure 6). The former uses mechanical devices to maintain the interface pressure and the latter uses elastic retention of silicone material itself. Pre-moulded silicone rubber sleeve is designed to fit with controlled interference over the cable insulation and is able to follow the cable's diameter variations still guaranteeing under any service condition a sufficient positive pressure to control the electric field concentration. The termination base plate and the cable's metallic sheath are electrically insulated from the supporting structure by means of stand off insulators designed to withstand both mechanical and electrical stresses in services. Upon request of the customer, either porcelain or composite hollow insulator can be supplied. And the insulator can be supplied in brown or grey colour. In addition upon request of the customer, arcing horn and shield ring can be supplied. The termination is filled with an insulating compound up to a level where the electric field is substantially reduced. The main insulation components are fully examined and tested in the factory. The maximum allowable cable conductor size is 3000mm²(6000kcmil).



Rating & Dimension (Based on pre-moulded type)

Max. Voltage kV	BIL kV	Max. Height mm	Max. Weight kg	Max. Creepage Distance mm
362	1175	4300	1700	13000
420	1425	4300	2000	14500
550	1550	5000	2500	20000

Selection of insulators with respect to polluted conditions (Based on IEC60815)

Pollution	I (Light)	II (Medium)	III (Heavy)	IV (Very Heavy)
Min. Nominal Specific Creepage Distance	16mm/kV	20mm/kV	25mm/kV	31mm/kV

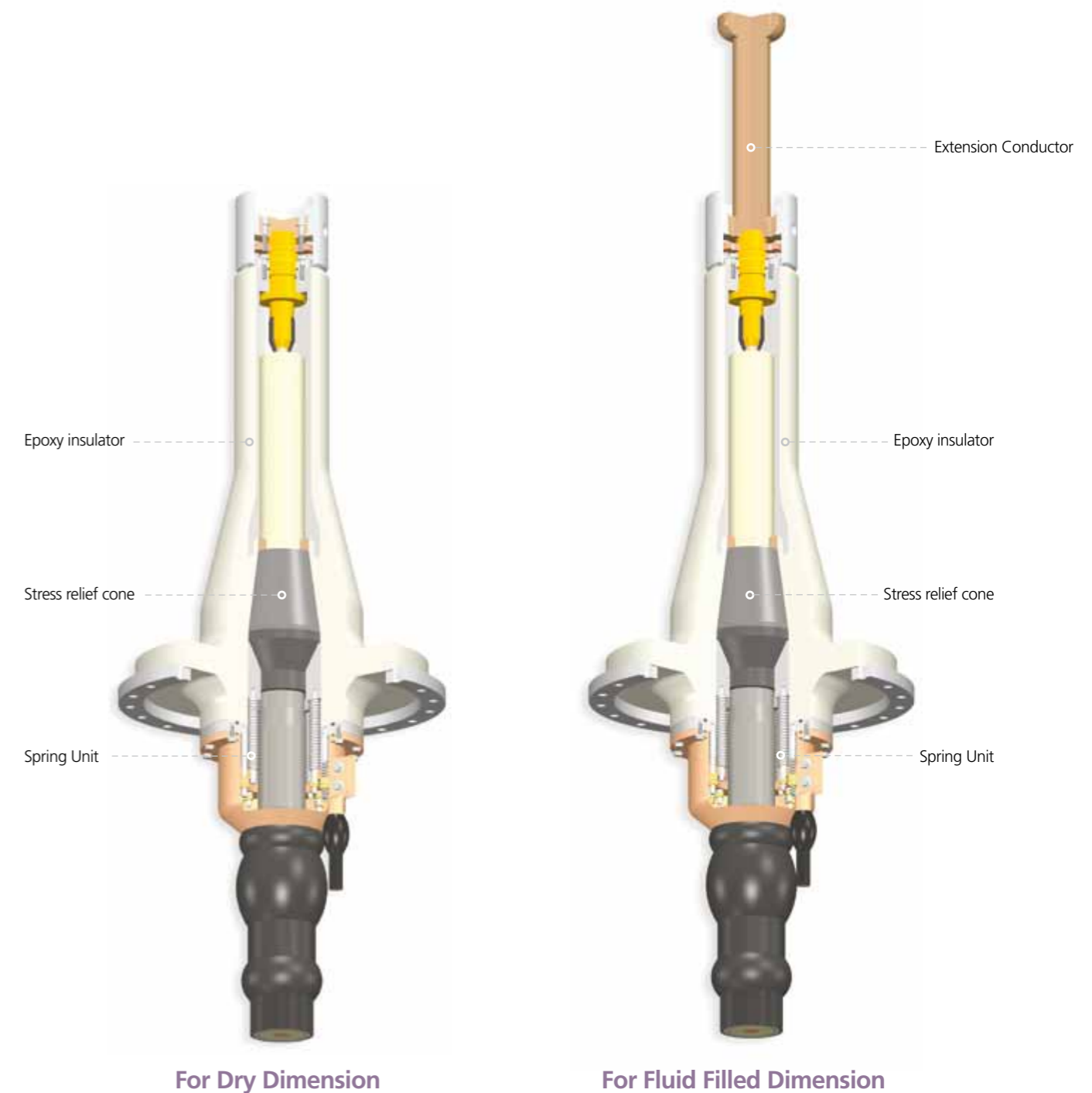

7.05 Oil-Immersed Terminations

The construction of SF₆ gas insulated terminations is based on the EPR(Ethylene-Propylene Rubber) or LSR(Liquid Silicone Rubber) - based stress relief cone and the epoxy resin housing. They are mechanical devices to maintain the interface pressure. Stress relief cone and mechanical devices are designed to fit with controlled interference over the cable insulation and is able to follow the cable's diameter variations still guaranteeing under any service condition a sufficient positive pressure to control the electric field concentration.

They also use epoxy insulating plate to isolate between cable sheath and GIS chamber. The SVLs(Sheath Voltage Limiter) can be installed to protect epoxy insulating plate from switching impulse. Upon request of the customer, we can supply three type of leading conductors. That is normal type, blind-ended type, plug-in type.

Design and scope of delivery are fully complying with IEC60859, IEC62271-209 and possibly adjusted to various needs of customers. The main insulation components are fully examined and tested in the factory. They are currently available at the voltage range up to 500kV and the maximum allowable cable conductor size is 3000mm²(6000kcmil).



Rating & Dimension (Based on IEC 60859)

Max. Voltage	BIL	Max. Height	Dimension of base plate	Max. Weight
kV	kV	mm	mm	kg
72.5	325	583	270	120
123	550	470	320	130
145	650	470	320	150
170	750	470	320	170
245	1050	620	582	280
420	1425	960	640	500
550	1550	960	640	600

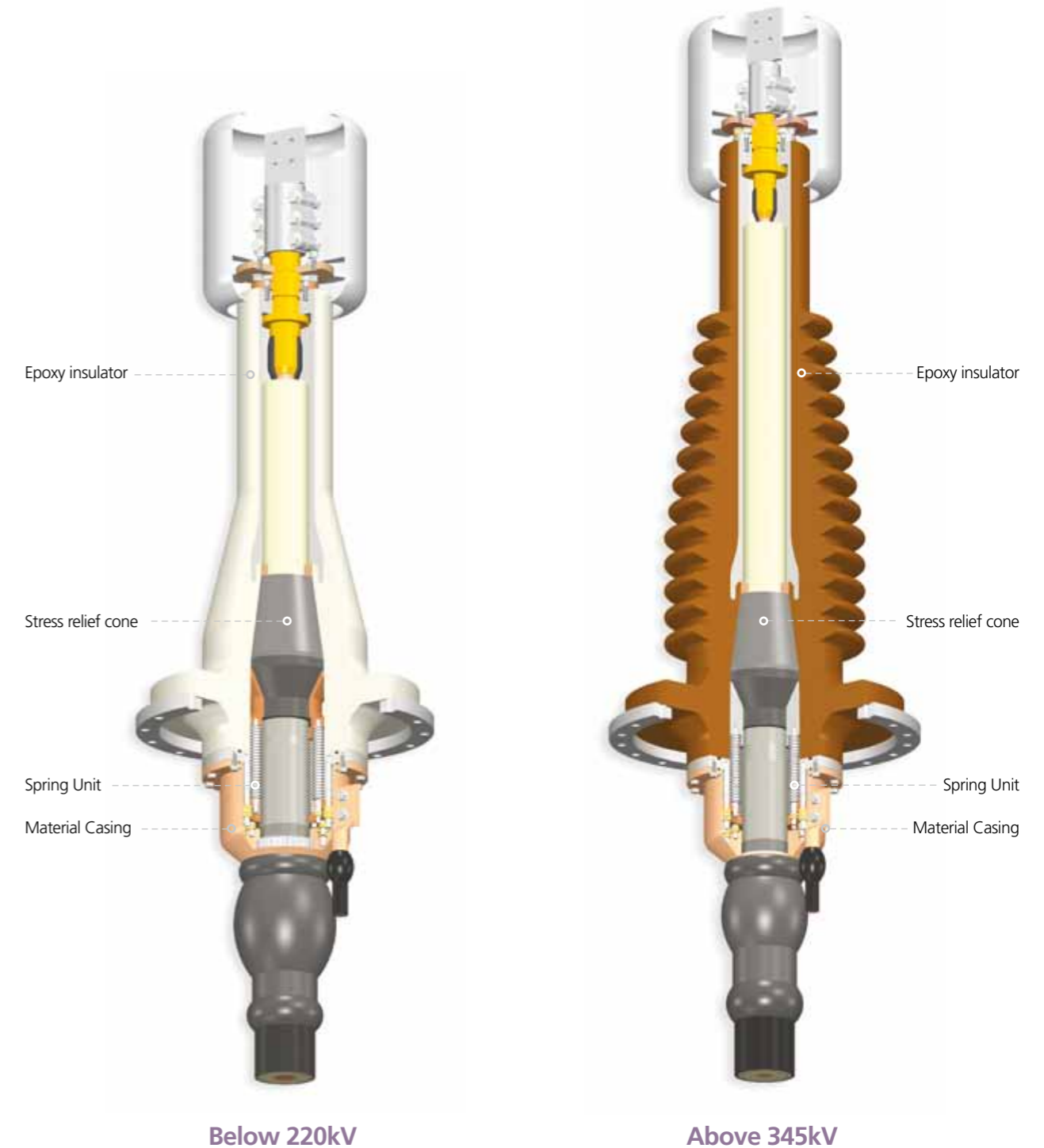

7.06 Pre-Moulded Joint(PMJ)

The construction of oil immersed terminations is based on the EPR(Ethylene-Propylene Rubber) or LSR(Liquid Silicone Rubber) - based stress relief cone and the epoxy housing. This is similar to gas insulated sealing end. But they use shield ring with insulating paper or epoxy insulated layer to prevent flashover in transformer. They are mechanical devices to maintain the interface pressure. Stress relief cone and mechanical devices are designed to fit with controlled interference over the cable insulation and is able to follow the cable's diameter variations still guaranteeing under any service condition a sufficient positive pressure to control the electric field concentration. The main insulation components are fully examined and tested in the factory. Dimensions of base paste are complying with various needs of customers. They are currently available at the voltage range up to 500kV and the maximum allowable size is 3000mm²(6000kcmil).



Rating & Dimension

Max. Voltage	BIL	Max. Height	Dimension of base plate	Max. Weight
kV	kV	mm	mm	kg
72.5	325	686	270	130
123	550	841	320	140
145	650	841	320	180
170	750	841	320	180
245	1050	1040	582	280
420	1425	1440	640	520
550	1550	1440	640	620

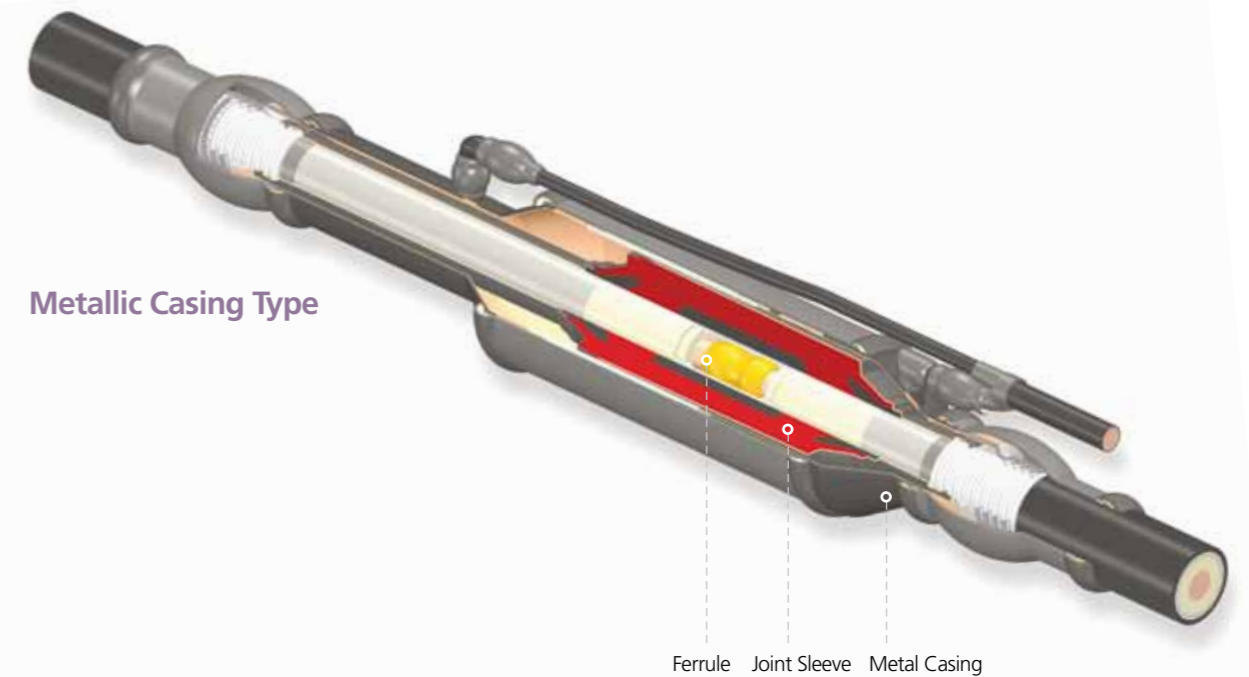

Coffin Box Type

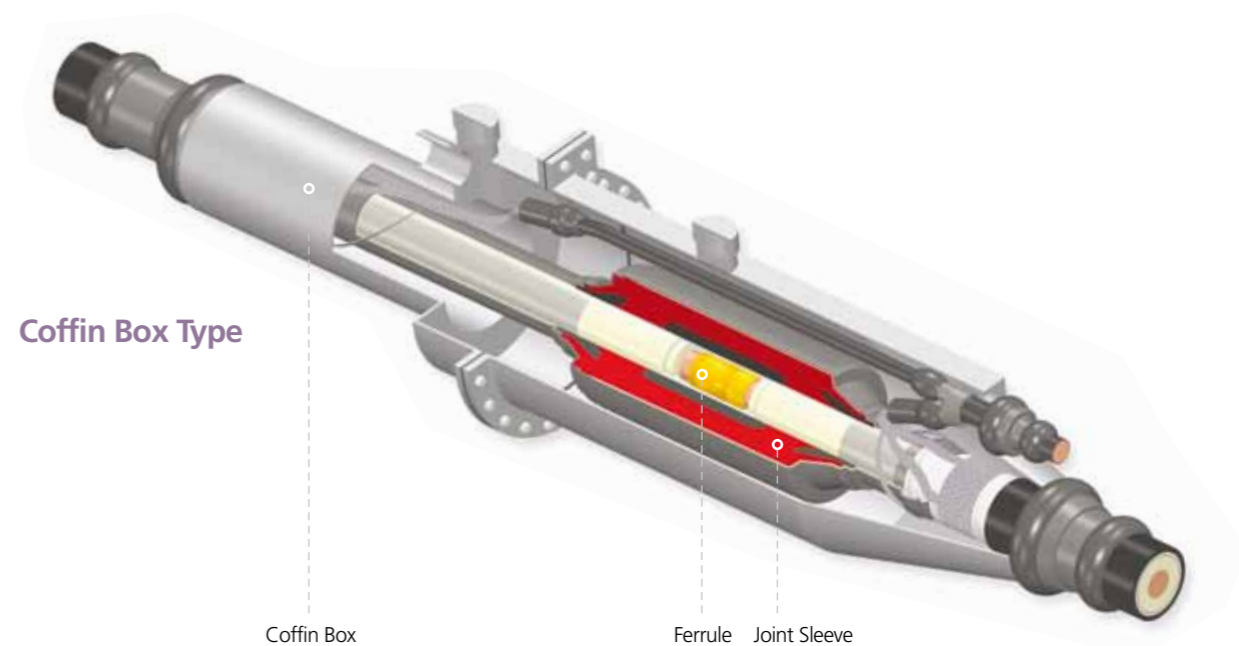

7.07 Link Box

Metallic Casing & Coffin Box Type

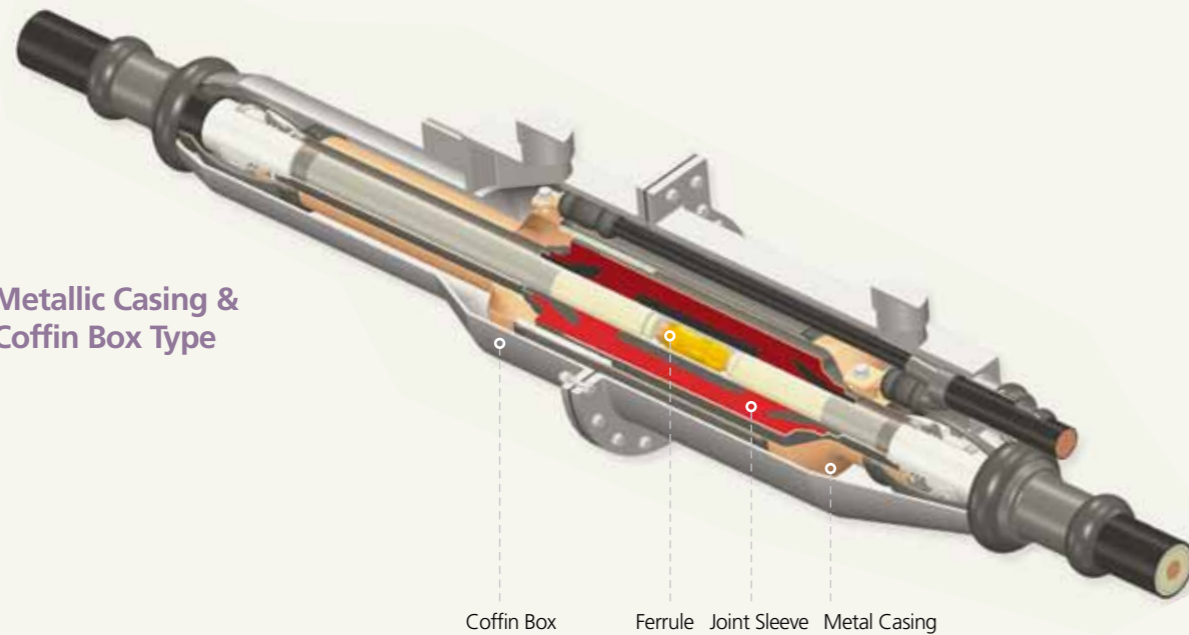

The single piece pre-moulded type rubber joint is based on silicone insulation embedded with two semi-conductive stress relief cones and one high voltage electrode. Without any mechanical devices, the interface pressure is safely maintained with elastic retention of material itself. Semi-conductive stress relief cones and electrode are designed to fit with controlled interference over the cable insulation and is able to follow the cable's diameter variations still guaranteeing under any service condition a sufficient positive pressure to control the electric field concentration. Upon request of the customer, outer casing is designed (metallic casing, coffin box, and metallic casing with coffin box). They use filling compound in outer casing. In case of sheath sectionalizing joint, we use insulating plate made of epoxy or FRP to disconnect between cable sheaths. The main insulation components and outer casing components are factory-made and fully tested before delivering to the site. The cost-efficient and simplified design along with easy and fast installation meets the various needs of customers. Installation tools can be provided if requested by customers. They are currently available at the voltage range up to 500kV and the maximum allowable conductor size is 3000mm²(6000kcmil).

Rating & Dimension (Based on Coffin Box Type)

Max. Voltage	Max. Length	Max. Outer Dia.	Max. Weight
kV	mm	mm	mm
72.5	2000	500	90
123	2000	500	120
145-170	2000	500	150
245-300	2200	550	200
362-420	2600	700	300
550	2700	700	400

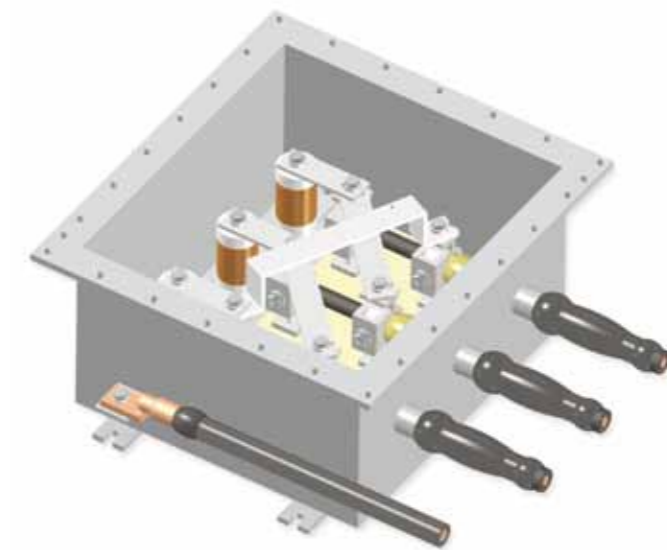

Buried Type : Link Box for cross bonding(3-1Way)



Gantry Mounted Type : Link Box for Earthing(3-1Way)

7.08 Transition Joint

Link Boxes are used at the end of cable termination to gain easy access to the cable metallic sheath and to limit the transient over-voltage induced on the metallic sheath by the lightning, switching operations and fault currents. Cross bonding(C.B.) link boxes allow metallic sheath to be transposed at cable joints with surge voltage suppression and reduction of circulation currents. Sheath voltage limiters(SVLs) in link box are the gapless ZnO arresters, which have the insulation resistance above 100MΩ at test voltage so that the sheath insulation can be checked without disconnection SVLs.

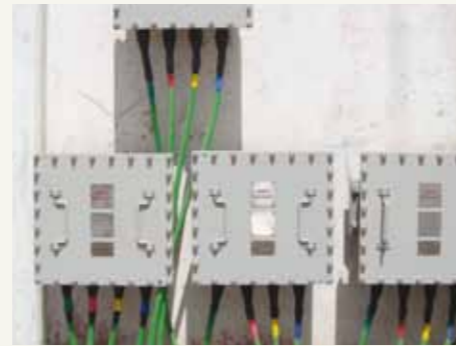

Standard Product	Box Type	Approx. Size mm	Bonding Lead	Approx. Weight kg
Link Box for Earthing(1-1Way)	Gantry Mounted / Buried	150X150 200X200	Single Core	15 30
Link Box for Earthing(3-1Way)	Gantry Mounted / Buried	300X500 350X600	Single Core	30 50
Link Box with SVLs(3-1Way)	Gantry Mounted / Buried	450X500 500X550	Single Core	40 70
Link Box for Cross-Bonding (3-1Way)	Gantry Mounted / Buried	500X550 550X600	Concentric	50 80
Link Box for Bonding & Earthing (3-1Way)	Buried	700X500	Concentric	80
Link Box for Earthing with SVL (3-1way)	Buried	700X500	Concentric	50

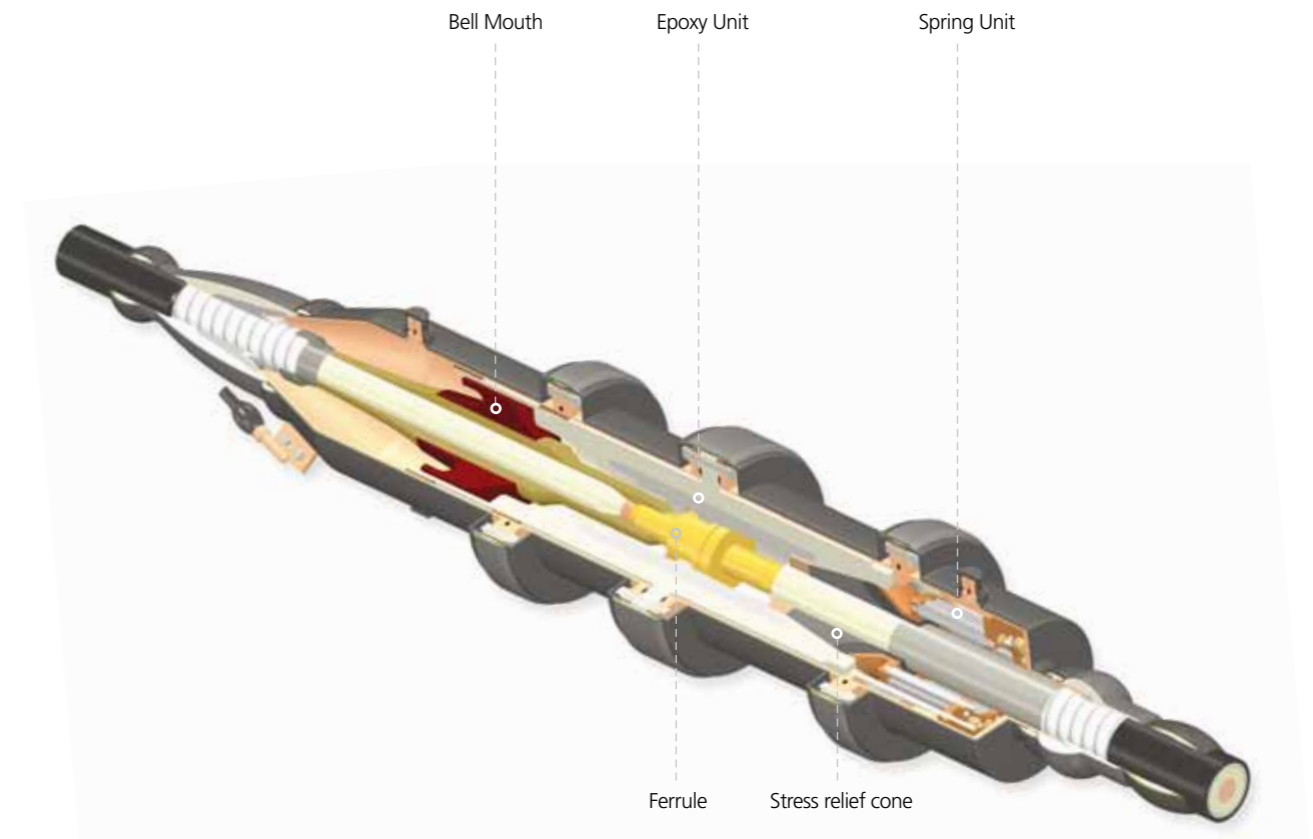

The transition joint connects between existing oil-filled cables and extruded dielectric cables. They comprise the stop joint with oil-impregnated paper insulation and epoxy bell mouth at side of oil-filled cables. They also comprise prefabricated type joint with stress relief cone based EPR(Ethylene-Propylene Rubber) and mechanical devices at side of extruded dielectric cables. They are designed to fit with controlled interference over the cable insulation and is able to follow the cable's diameter variations still guaranteeing under any service condition a sufficient positive pressure to control the electric field concentration. Each components fully examined and tested in the factory. They are currently available at the voltage range up to 300kV and the maximum allowable cable conductor size is 3000mm²(6000kcmil).

Rating & Dimension

Max. Voltage kV	Max. Length mm	Max. Outer Dia. mm	Max. Weight mm
145	1800	290	220
170	1800	320	250
245	2000	360	300

7.09 Optical Cable & Joint

These type for power cable are very useful to measure distributed temperature. Especially optical cable located the sensing fiber to the cable core provides a better indication of conductor temperature. We can supply optical joint to connect optical fiber cable.

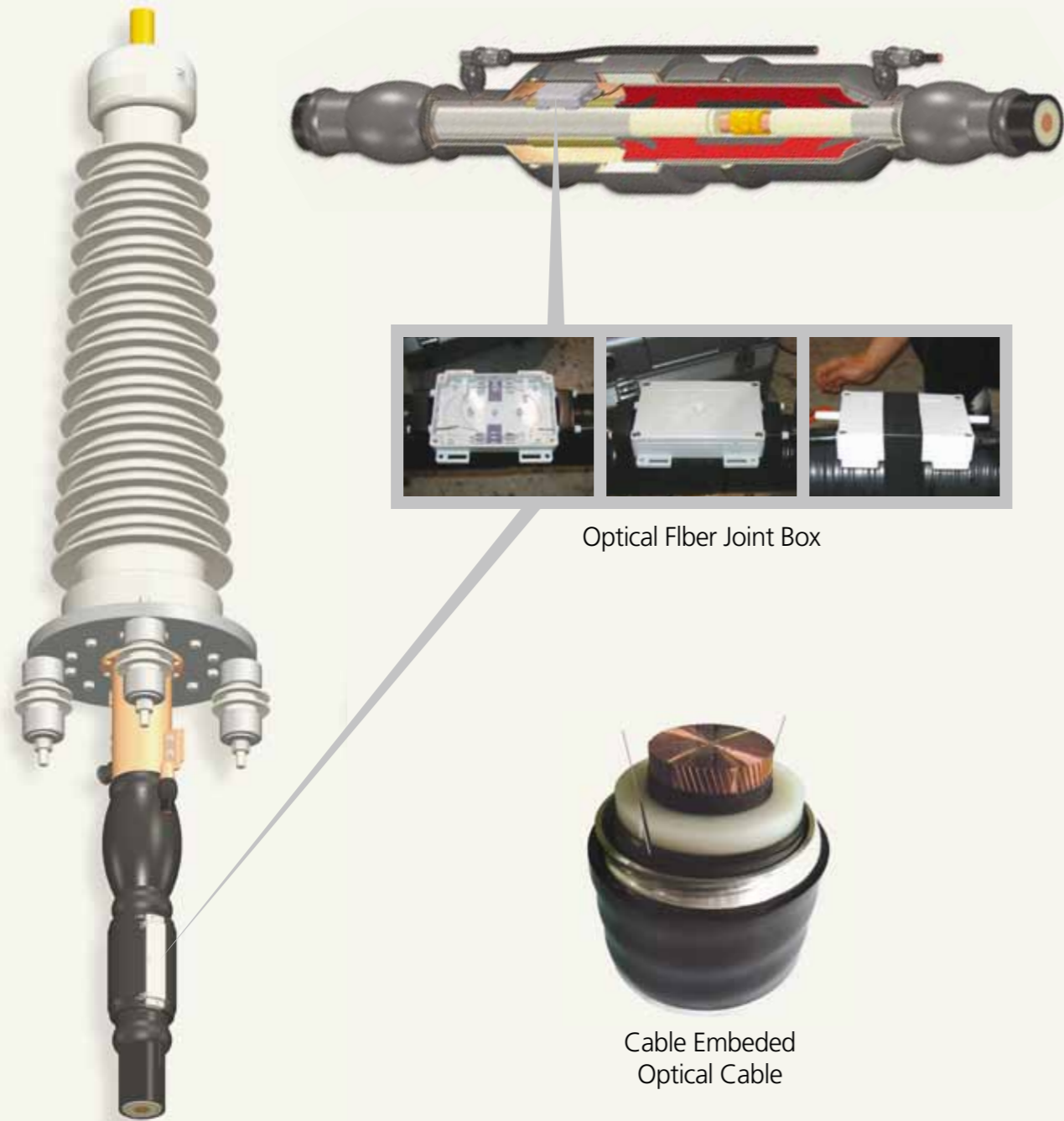

8.00 Monitoring & Diagnosis System

- 8.01 Real Time Thermal Monitoring-Underground Power Cable System
- 8.02 On-Site PD Detection System

8.01 Real Time Thermal Monitoring-Underground Power Cable System

Real time thermal monitoring cooperated with DTS* system using optical fiber as the sensor provides high efficiency and reliability of power cable system.

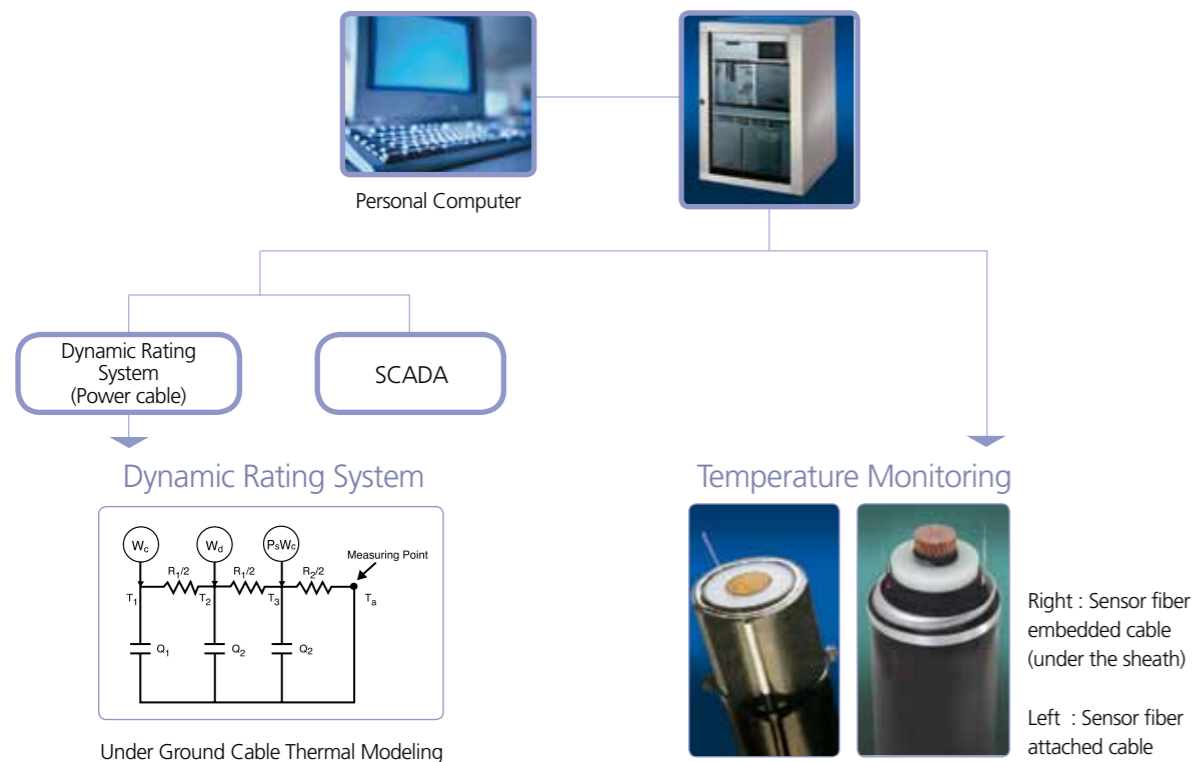

Thermal models and real-time temperature measurement can provide dynamic rating system. And this system allows qualification of actual cable capacity, cable conditions and environmental parameters critical to the stability and longevity of the cable system.

These types of power cable are very useful to measure distributed temperature. Especially, the right cable, located the sensing fiber closer to the cable core, provides a better indication of conductor temperature.

Dynamic Cable Rating Systems (R-TAS™)

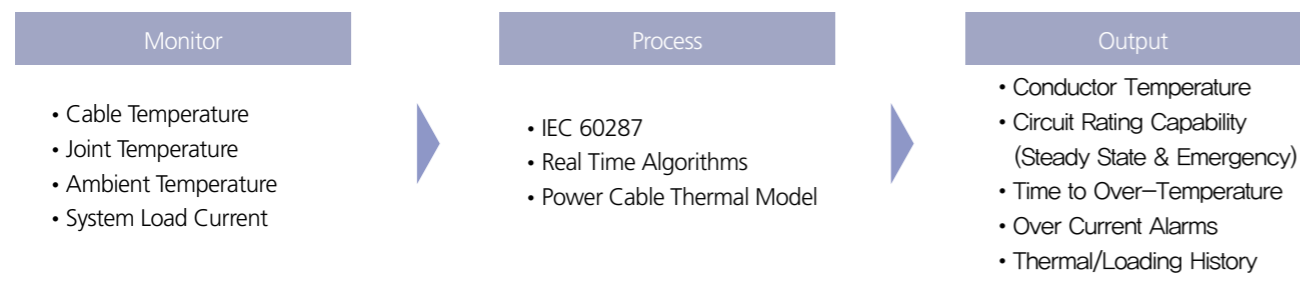

*Distributed Temperature Sensor : Supplied by Sensa, UK. For more information, refer to www.sensa.org

8.02 On-Site PD Detection System

On-Site PD Detection based on high frequency PD measurement can be a highly effective method to increase the reliability of XLPE power cable system not only as after-laying test but also as on-site insulation diagnosis.

Characteristics of On-Site PD Detection System

- High sensitivity by tuning low noise frequency range
- System configuration without line-off
- Easy installation of PD sensor
- Pattern recognition by ϕ -q-n analysis
- PD localization using PD attenuation property

Sensor Type

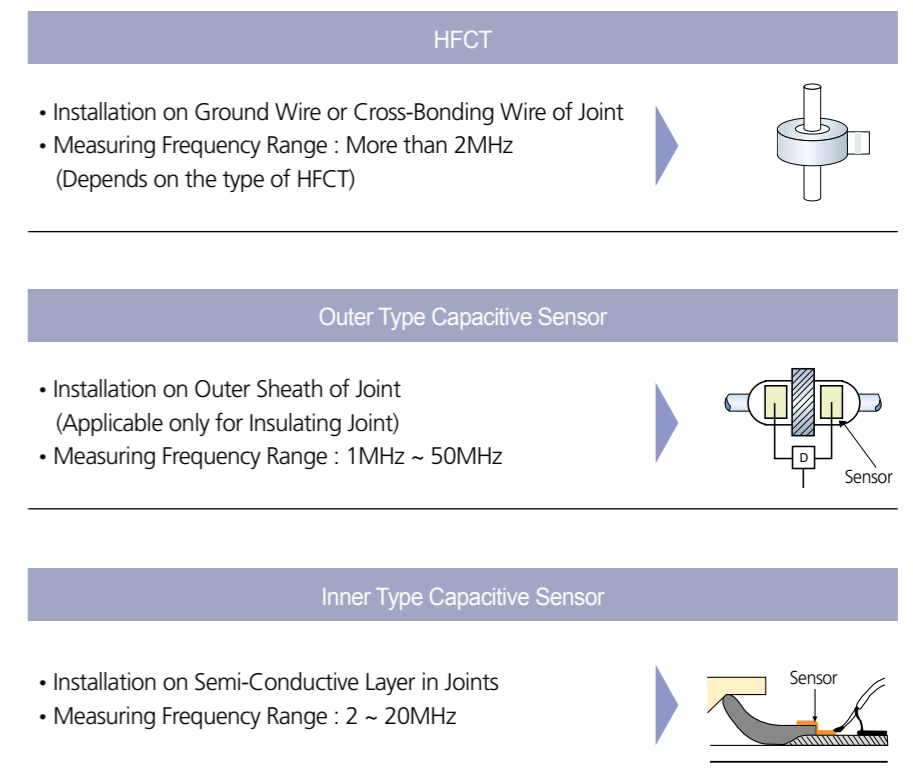

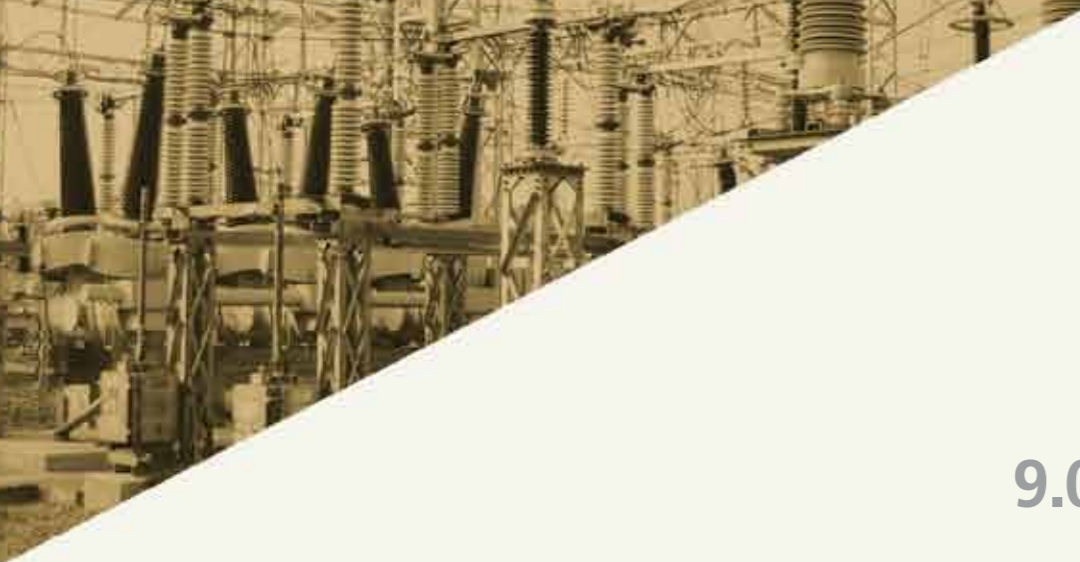

9.01 Type Test/Pre-Qualification Test Certificates

9.00 Appendix

9.01 Type Test/Pre-Qualification Test Certificates

9.02 ISO Certificates



The reliability of XLPE cable systems are fully verified by internationally accredited independent laboratories, KEMA (Netherlands), CESI (Italy), Kinetrics (Canada) and KERI (Korea).

Certificates for XLPE cable system over 230kV

Year	Voltage Grade	Spec.	Test Items	Certificate Issued by	Test
1999	400kV, 1200mm ²	IEC 62067	Cable, PJ, GIS & Outdoor Termination	KEMA	Type Test
2001	230kV, 1200mm ²	IEC 62067	Cable, PMJ, GIS & Outdoor Termination	KEMA	Type Test
	345kV, 2000mm ²		Cable, PJ, GIS & Outdoor Termination	KERI(KEPCO)	Type Test
2002	345kV, 2000mm ²	IEC 62067	Cable, PJ, GIS & Outdoor Termination	KERI(KEPCO)	PQ
	400kV, 1200mm ²		Cable, PJ, GIS & Outdoor Termination	KEMA	PQ
2003	345kV, 2500mm ²	IEC 62067	Cable, PJ, GIS & Outdoor Termination	KEMA	Type Test
2004	345kV, 2500mm ²	IEC 62067	Cable, GIS & Outdoor Termination	KEMA	PQ
	400kV, 2500mm ²		Cable, PMJ, GIS & Outdoor Termination	KEMA	Type Test
2006	230kV 800SQ	IEC 62067	Cable, GIS, Outdoor Termination	SGS	Type Test
	345kV 2500SQ		Cable, PMJ, Outdoor Termination	KEMA	Type Test
	345kV1500SQ		Cable, PMJ, Outdoor Termination	KEMA	Type Test
2007	380kV2500SQ	IEC 62067	Cable, GIS, Outdoor Termination	KEMA	Type Test
	345kV2500SQ		Cable, GIS, PMJ, Outdoor Termination	KERI(KEPCO)	Type Test
2009	500kV 2500SQ	IEC 62067	Cable, GIS, PMJ, Outdoor Termination	KEMA, CEPRI	Type Test
2011	220kV 1000SQ	IEC 62067	Cable, GIS, PMJ, Outdoor Termination	KEMA	Type Test
	2250kV 2500SQ(20t)		Cable, GIS, PMJ, Outdoor Termination	KEMA	Type Test
2012	400kV 2500SQ	IEC 62067	Cable(Enamelled Cu), PMJ, GIS, Outdoor Termination	KEMA	Type Test
2013	400kV 2500SQ	IEC 62067	Cable, PMJ, GIS, Outdoor Termination	CESI	PQ
	230kV 3500KCM		Cable, PMJ, GIS, Outdoor Termination	KEMA	Type Test
2014	380kV 2500SQ	IEC 62067	Cable, PMJ, GIS, Outdoor Termination	KEMA	Type Test
2015	500kV 2500SQ	IEC 62067	Cable, PMJ, GIS, Outdoor Termination	KEMA, CEPRI	PQ

9.02 ISO Certificates

MEMO

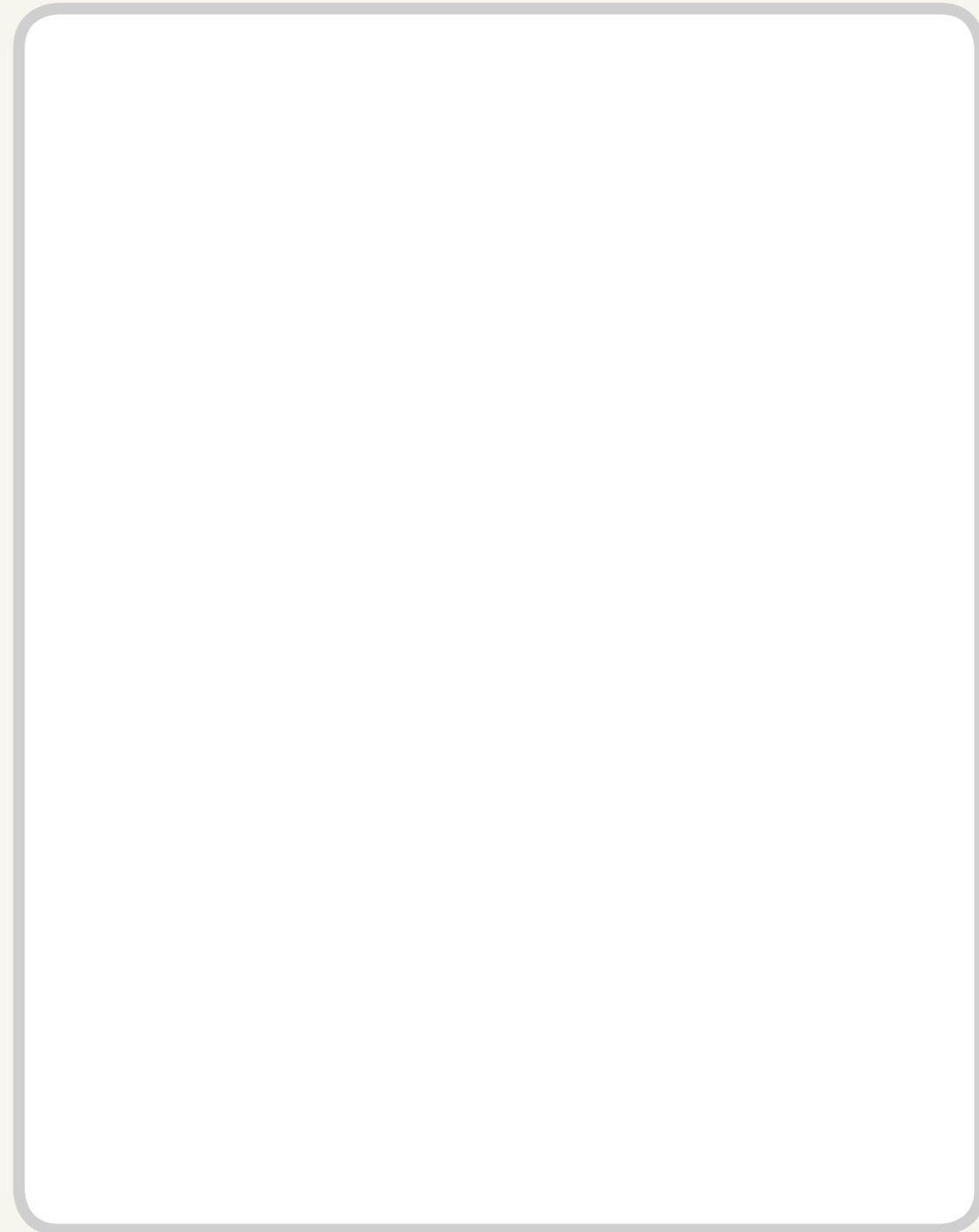

We do what it takes to earn quality certifications like ISO 14001, ISO 9001, and IATF 16949 which sets standards for process control and manufacturing flow.

GLOBAL NETWORK

More than 60 Factories,
Sales and Production Sites
in 20 Countries.

- Factory
- Sales office
- Branch office



KOREA



Gumi Plant
EHV / MV / LV cable
UTP, Coaxial cable
SCR, Magnet wire
Overhead cable, Bus duct



Indong Plant
Optical fiber
Optical cable



Donghae Plant
Submarine cable
Industrial specialty cable

CHINA



LSHQ(Yichang)
EHV / MV / LV cable
Industrial specialty cable



LSCW(Wuxi)
Industrial devices cable
Automotive cable
Harness & module
Aluminum, Bus duct

VIETNAM



LS-VINA(Haiphong)
EHV / MV / LV cable
SCR, ACSR
Overhead cable



LSCV(HO Chi Minh)
MV / LV cable
UTP, Optical cable
Overhead cable

INDIA



LSCI(Bawal)
EHV / MV / LV cable
Coaxial cable
Overhead cable

USA



LSCUS(Tarboro)
MV / LV cable
Control, Instrument cable

POLAND



LS EV Poland./LSCP (Dzierzoniow)
Automotive battery components
Optical cable



www.lscns.com
LS EHV Cable System

19F LS Yongsan Tower, 92 Hangang-daero, Youngsan-gu, Seoul 03486 South Korea
Tel. 82-2-2189-9114

©2020 LS Cable & System Ltd. All right reserved.

This product or document is protected by copyright and distributed under licenses restricting its use, copying, distribution, and recompilation. No part of this product or document may be reproduced in any form by any means without prior written authorization of LS Cable&System and its licensors, if any.

Products shown on this catalog are subject to change without any prior notice.